

2-way and 3-way globe valves

Table of contents

Background

Project planning	2
Flow characteristics	2
Principles of flow control	3
Hydraulic circuits	4

Design and dimensioning

Design for use with glycol	5
Design in low-pressure steam applications	5
Dimensions diagram for 2-way and 3-way globe valves	6
Selection of globe valves	7
Selection of linear actuators	7

Project planning

Relevant information	The data, information and limit values listed on the data sheets for the globe valves and linear actuators are to be taken into account and/or complied with, respectively.
Closing pressures	Maximum closing pressures Δp_s are dependent on the valve size and the drive force. The values for all valve-actuator combinations are to be found in the closing pressure table «Overview Valve-actuator combinations».
Pipeline clearances	The minimum clearances between the pipelines and the walls and ceilings required for project planning depend not only on the valve dimensions but also on the selected actuator. The dimensions are defined in the «Globe valves» data sheets.
2-way globe valves	2-way globe valves are to be provided as throttling devices in the return. This leads to lower thermal loads on the sealing elements in the valve. The prescribed flow direction must be observed.
3-way globe valves	3-way globe valves are mixing devices. The flow direction must be observed for all pressure levels. Installation in the supply or return is dependent on the selected hydraulic circuit. In the case of the diverting circuit, it is recommended that a balancing drive be provided in the bypass line.
Note The 3-way globe valve may not be used as a diverting valve.	
Dirt filter	Globe valves are regulating devices. The use of dirt filters is recommended in order to prolong their service life as modulating instruments.
Shut-off devices	Care must be taken to ensure that sufficient numbers of shut-off devices are installed.
Water quality	The water quality requirements specified in VDI 2035 must be adhered to.

Flow characteristics

2-way globe valve	The characteristic curve is equal-percentage, with a characteristic curve factor $n(gl) = 3$. This guarantees stable control characteristics in the elevated partial load range. The curve is linear in the lower opening range between 0 ... 30% stroke. This ensures outstanding control characteristics, including in the lower partial load range, see graph on the right.
3-way globe valve with equal percentage control path (valves H5..B, H7..R, H7..N)	Same behaviour via the control path A-AB as with the 2-way globe valves. The bypass B-AB exhibits the same k_{vs} value as the control path. The characteristic curve in the bypass is linear, see graph on the right.
3-way globe valve with linear control path (valves ..W..S, H7..X..S, H7..Y..S)	Control path A-AB and bypass B-AB both exhibit a linear characteristic curve and the same k_{vs} value, see graph on the right.

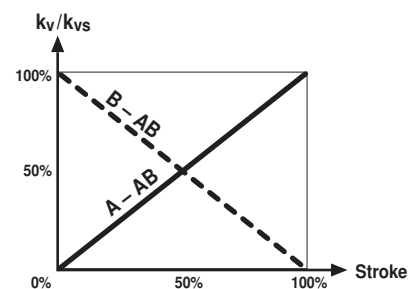
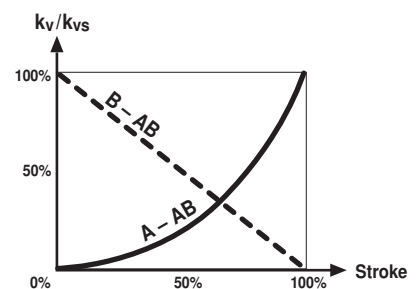
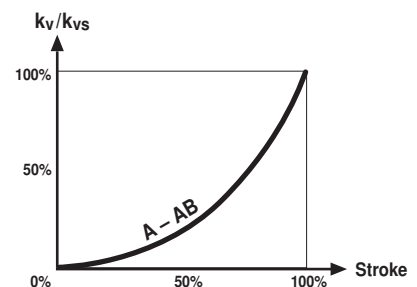
**Note**

The flow characteristics are achieved by the profiling/geometry of the valve cone.

Principles of flow control

Direction of flow The flow direction of the medium always runs against the cone which closes the control path.

3-way globe valve with closing point at bottom

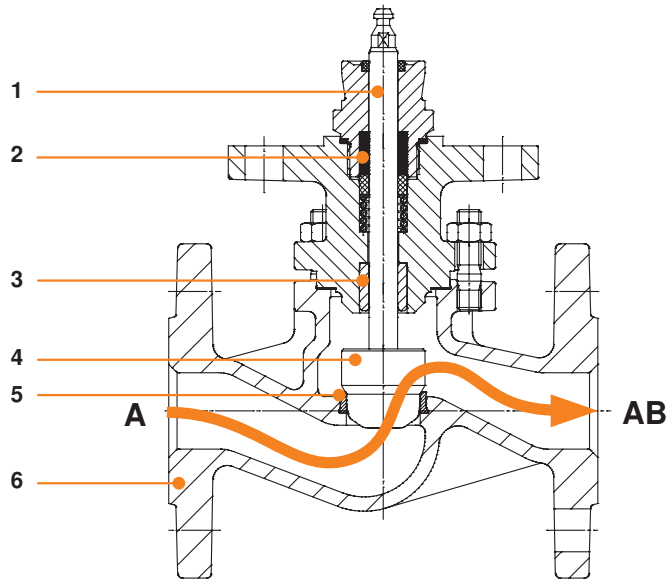

Section through an H6..S

Legend	
1	Valve stem
2	Stem extension
3	Stem guide
4	Valve cone
5	Valve seat (A-AB)
6	Valve

3-way globe valve with closing point at top

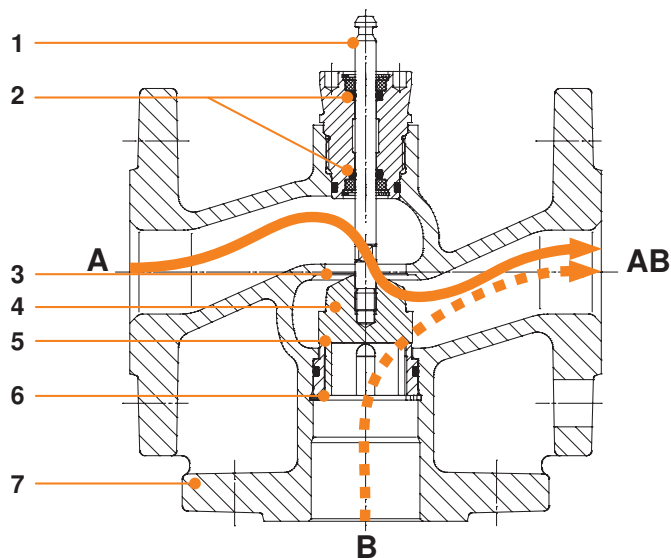

Section through an H7..N

Legend	
1	Valve stem
2	Stem extensions
3	Valve seat (A-AB)
4	Valve cone
5	Valve seat Bypass (B-AB)
6	Axial fuse valve cone
7	Valve

Partial pressure-reduced 2-way globe valve with closing point at bottom

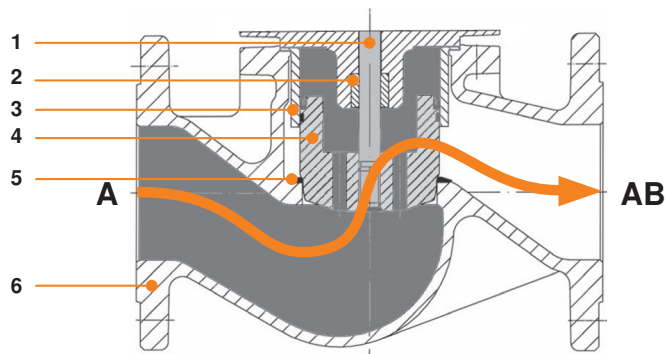

Section through an H6..SP

Legend	
1	Valve stem
2	Stem guide
3	Piston guide
4	Valve cone
5	Valve seat (A-AB)
6	Valve

Function The partial pressure reduction occurs as the result of the supply pressure of the medium (from Port **A**) also having an effect on the opposite side of the valve cone through the borehole in the valve cone. The actuator therefore only has to deliver the pressure force to ensure that the piston does not leak in its seat. As a result, much greater closing pressures can be achieved than is the case with non-partial pressure-reduced valves.

Hydraulic circuits

Control characteristics In order to ensure that a valve achieves good control characteristics, thus making it possible to ensure a long service life for the final controlling element, proper configuration of the valve with the correct valve authority is required.

The valve authority a_v is the measure of the control characteristics of the valve in conjunction with the hydraulic network. The valve authority is the ratio between the differential pressure of the completely opened valve at the nominal flow rate and the maximum differential pressure occurring with the closed valve. The greater the valve authority, the better the control characteristics. The smaller the valve authority a_v becomes, the more the operational behaviour of the valve will deviate from the linearity, i.e. the poorer the behaviour of the volumetric flow control. An a_v of >0.5 is strived for in everyday practice.

Differential pressures Δp_{v100} with globe valve completely open

Circuit	2-way globe valves: H4..B / H6..R / H6..N / H6..S / H6..SP / H6..W..S / H6..X..S		3-way globe valves: H5..B / H7..R / H7..N / H7..W..S / H7..X..S / H7..Y..S		
	Throttling circuit	Injection circuit with throttling device	Diverting circuit	Mixing circuit	injection circuit with 3-way characterised control valve
	$\Delta p_{v100} > \Delta p_{VR} / 2$ Typical values: 15 kPa $< \Delta p_{v100} < 200$ kPa	$\Delta p_{v100} > \Delta p_{VR} / 2$ Typical values: 10 kPa $< \Delta p_{v100} < 150$ kPa	$\Delta p_{v100} > \Delta p_{MV}$ Typical values: 5 kPa $< \Delta p_{v100} < 50$ kPa	$\Delta p_{v100} > \Delta p_{MV}$ Typical values: $\Delta p_{v100} > 3$ kPa (with depressurised distributor). Other mixing circuits: 3 kPa $< \Delta p_{v100} < 30$ kPa	$\Delta p_{MV1} + \Delta p_{MV2} \approx 0$ Typical values: $\Delta p_{v100} > 3$ kPa
Geographical depiction					
Synoptic depiction					

Legend:

	Globe valve, 2-way, with linear actuator	VL — Supply	Δp_{VR} Differential pressure at the respective branching (supply / return) at nominal load
	Globe valve, 3-way, with linear actuator	RL Feedback	Δp_{MV} Differential pressure in quantity-variable part with nominal load (e.g. exchanger)
	Pump		Non-return valve
	Balancing valve		

Design for use with glycol

Salts were formerly added to the water to reduce its freezing point; this was referred to as brine applications. Nowadays, glycols are used and one speaks of refrigerant agents. Depending on the concentration of the refrigerant agent (type of glycol) used and the medium temperature, the density of the water/glycol mixture varies from 1 ... 9%. The volumetric deviation which results from this process is less than the permitted quantity tolerance of the k_{VS} value of the valve (of $\pm 10\%$ in accordance with VDE 2173) and need not as a rule be taken into account, even if glycols require a slightly elevated k_V value. Depending on the type of glycol, tolerance with the valve materials used must be ensured and the permitted maximum concentration may not be exceeded.

Rounding-off rules In practice, the desired k_V value never exactly matches the available k_{VS} value of a valve. It is therefore either the next largest or the next smallest valve which is selected when it comes to selecting the valve. This could lead to two situations:

1. The desired k_V value is not exactly between two k_{VS} values. Rounding is done then either up or down, accordingly.

Exemplary A valve is needed with a k_V value of 4.8 m³/h. The k_{VS} values 4 m³/h and 6.3 m³/h are available, and a k_{VS} value of 4 m³/h is then selected.

2. The desired k_V value is exactly between two k_{VS} values. It is recommended that one select as follows:

- 2-way valve – the smaller k_{VS} value
- 3-way valve – the larger k_{VS} value

Exemplary A valve is needed with a k_V value of 5.15 m³/h. The k_{VS} values 4 m³/h and 6.3 m³/h are available. Accordingly, a k_{VS} value of 4 m³/h is selected for the 2-way valve and a k_{VS} value of 6.3 m³/h is selected for the 3-way valve.

Design in low-pressure steam applications

Alignment and installation position

Trouble-free operation in steam applications depends on the correct installation position and design of the control valve. The arrangement of the steam pipeline and the positioning of the condensation drain are also decisive.

Restrictions

Belimo control valves may only be used in steam applications which involve a subcritical steam-pressure ratio of between 0 and 0.4, and then only with equal percentage valve characteristic curves (medium speed v max. 50 m/s).

Installations with a resulting pressure ratio in the supercritical range between 0.4 and 1 are not permitted with Belimo valves.

Steam ratio

$$\frac{p_{1(\text{abs})} - p_{2(\text{abs})}}{p_{1(\text{abs})}}$$

Pressure specifications in absolute pressures

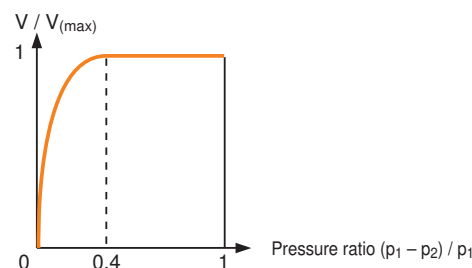

Dimensions diagram for 2-way and 3-way globe valves

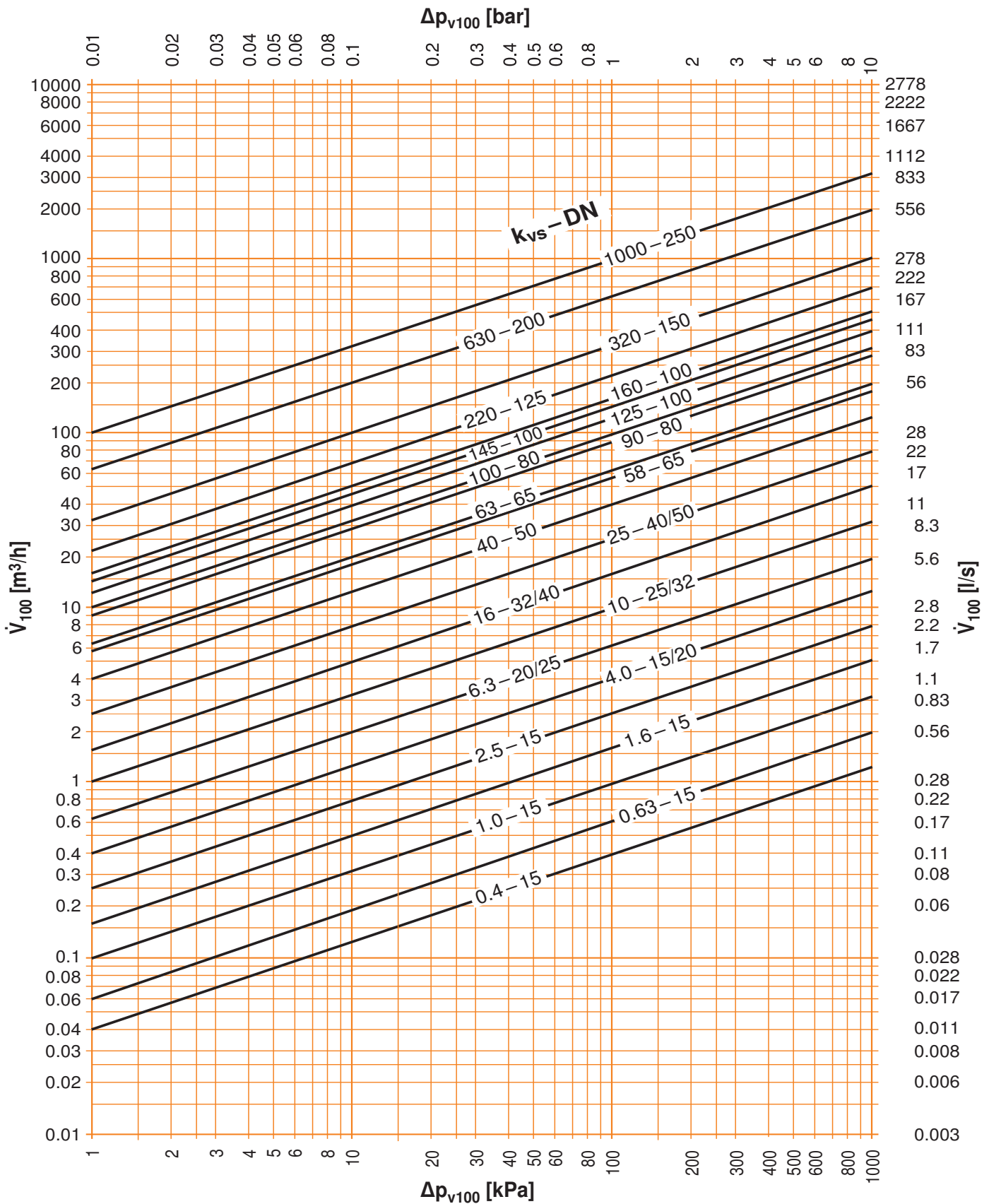

Δp_{max}
Maximum permitted pressure difference for long service life across control path A – AB, with reference to the whole range of opening.

Δp_{V100}
Pressure difference with globe valve completely open.

\dot{V}_{100}
Nominal flow rate with Δp_{V100}

Δp_s
Closing pressure at which the linear actuator can still seal the fitting tightly, with reference to the particular leakage class.

Formula k_{vs}

$$k_{vs} = \frac{\dot{V}_{100}}{\sqrt{\frac{\Delta p_{V100}}{100}}}$$

k_{vs} [m³/h]
 \dot{V}_{100} [m³/h]
 Δp_{V100} [kPa]

Selection of globe valves

Pressure class / rated pressure p_s		PN6		PN16						PN25		PN40		
Max. differential pressure Δp_{max} [kPa]		400		400						1000		1000		
Valve design (2-way / 3-way)														
Flange (ISO 7005-2)														
External thread (ISO228)														
Valve characteristic curve — Control path A-AB - - - - Bypass B-AB														
Globe valve		H6..R	H7..R	H4..B	H5..B	H6..N	H7..N	H6..W..S	H7..W..S	H6..S	H6..SP	H6..X..S	H7..X..S	H7..Y..S
k_{vs}	DN													
0.4	15													
0.63														
1														
1.6														
2.5														
4	20													
6.3														
10	25													
16														
25	40													
40														
58	65													
63														
90														
100	80													
125														
145	100													
160														
220														
320	150													
630	200													
1000	250													
Max. closing pressures Δp_s		Depending on the drive force – values in the closing pressure table «Overview Valve-actuator combinations»												

Selection of linear actuators

- For all possible combinations with linear actuators and the closing pressures they achieve, see «Overview Valve-actuator combinations»
- For detailed information concerning linear actuators, see the data sheets for the linear actuators

All-inclusive.



Switzerland

BELIMO Automation AG
Sales Switzerland
Brunnenbachstrasse 1
CH-8340 Hinwil, Switzerland
Tel. +41 (0)43 843 62 12
Fax +41 (0)43 843 62 66
verkch@belimo.ch
www.belimo.ch

Benelux

BELIMO Servomotoren BV
BENELUX
Postbus 300, NL-8160 AH Epe
Radeweg 25, NL-8171 MD
Vaassen
Tel. +31 (0)578 57 68 36
Fax +31 (0)578 57 69 15
info@belimo.nl
www.belimo.nl

Germany

BELIMO Stellantriebe
Vertriebs GmbH
Welfenstrasse 27
D-70599 Stuttgart
Tel. +49 (0)711 1 67 83-0
Fax +49 (0)711 1 67 83-73
info@belimo.de
www.belimo.de

At no charge

Orders:
Tel. **0711 1 67 83-83**
Technical consulting:
Tel. **0711 1 67 83-84**
Fax **0711 1 67 83-73**

Personal consultation with Regional Sales Director in:

Berlin, Hanover, Dusseldorf
Leipzig, Frankfurt, Munich
Hamburg, Stuttgart

Austria

BELIMO Automation
Handelsgesellschaft m.b.H.
Geiselbergstrasse 26-32
A-1110 Vienna, Austria
Tel. +43 (0)1 749 03 61-0
Fax +43 (0)1 749 03 61-99
info@belimo.at
www.belimo.at

Austria West

Tel. +43 (0)644 14 26 365
Fax +43 (0)732 70 10 51
dietmar.niederhametner@belimo.at

Hungary

Tel. +36 (06)20/920 46 16
Fax +36 (06)23/37 77 30
gabor.koeves@belimo.at

Slovakia

Tel. +43 (0)1 749 03 61-0
Fax +43 (0)1 749 03 61-99
info@belimo.at

Slovenia/Croatia/Bosnia

Tel. +386-(0)41-75 89 63
Fax +386-(0)4-2342-761
samo.smid@belimo.at

Serbia/Montenegro/ Macedonia/Bosnia

Tel./Fax +381-(0)11 311-9127
branimir.petrovic@belimo.at