

Belimo Gateway MP to LONWORKS® - UK24LON

Contents

Complete Overview	2
Technical Data	3
Safety Notes	4
Product features	4
Installation and commissioning	4
Electrical installation	5
Dimensions	7
Operation	8
Error & Status indication	10
Functional Profile	11
Connecting the PC-Tool for parameterizing of the MP-actuators	16
Version overview	17

Complete Overview

Gateway MP / LONWORKS®



Suitable MP/MPL/MFT(2)-Actuators

Damper actuators



VAV actuators



Actuators for characterised control valve, butterfly valves and globe valves



EPIV actuators



MPL actuators



Gateway MP to LONWORKS®.MP-bus-capable Belimo actuators can be connected on the MP-Bus side.

- Interface MP – LONWORKS®
- Connection of MP/MPL/MFT(2)-actuators to LONWORKS®
- Up to 8 actuators and sensors can be connected



Technical Data

Electrical data	Nominal Voltage	AC 24V, 50/60 Hz / DC 24V
	Power supply range	AC / DC 21.6...26.4 V
	For wire sizing	3 VA / 1.5 W
	Connection	LONWORKS® Plug-screw terminal, 2-pin
	Supply	Plug-screw terminal, 2-pin
Functional data	MP-Bus	Plug-screw terminal, 4-pin (All terminal suitable for 2 x 1.5mm ²)
	Tool	3 Pin Weidmüller plug
	Supported actuators	MP/MPL/MFT(2)
	Quantity of actuators	max. 8 pcs.
	Communication with actuators	Belimo MP-Bus, Master-Slave, 1200 Bd
Safety	Maximum signal conductor lengths MP	Dependent on the number of connected actuators, actuator type, type of supply and signal conductor cross-section For details see page 5
	LONMARK® Functional Profile	Node Object #0 Damper Actuator Object #8110 Open Loop Sensor Object #1 For detailed information see www.lonmark.org
	Medium	FTT-10A
	Baudrate	78 kbit/s
	Protection class	III Safety extra-low voltage
Installation / Dimension / Weight	EMC	CE pursuant to 89/336/EWG, 92/31/EWG, 93/68/EWG
	Ambient temperature	0...+50° C
	Mounting	Control cabinet installation, can be snapped onto top hat rail 35 mm
	Dimensions	see page
	Weight	ca. 500g

Safety Notes



- The device is not allowed to be used outside the specified field of application.
- It may be installed only by suitably trained personnel.
- The device does not contain any parts that can be replaced or repaired by the user and may only be opened at the manufacturer's site.

Product features

Mode of operation	Through the UK24LON unit the actuators can be controlled digitally over the MP-Bus and they also provide feedback of their current operating status. In the UK24LON unit the digital data for control and feedback is converted to standard network variables (SNVT's). This allows the functions of the actuators to be linked directly to LONWORKS®.
Sensor connection	One sensor can be connected to each MP- actuator. It can be either a passive resistance-type sensor (Pt1000, Ni1000 or NTC), an active sensor (e.g. with a DC 0...10 V output) or a switching contact. This provides a simple means of digitising the analogue signal from the sensor through the actuator so that it can be passed on to LONWORKS® via the UK24LON unit. MPL-actuators do not have a sensor input.

Installation and commissioning

Installation and wiring	The device is mounted on 35 mm top hat rails. The wiring is accomplished with plug-screw terminals.
Commissioning and parameterisation	<p>The implementation is done via LNS engineering Tool (e.g. LONMaker, NLUtility)</p> <p>The addressing of the LON device can be done by using the Neuron ID and an LNS Engineering Tool.</p> <p>The parameterization of the sensors, which are connected on the actuators, and further settings can be done using the corresponding Plug Ins (Damper Actuator Plug In, Sensor Plug In)</p> <p>The addressing of the MP actuators is accomplished either with the keys on the front cover, with the Belimo PC-Tool MFT-P or the ZTH-GEN.</p> <p>The MP-Bus assignment is stored on the device.</p>

Electrical installation

Wiring diagram

AC/DC 24 V supply
 Connection via safety isolation transformer!

Dimensioning of the supply
 Also take into account the dimensioning specifications of the connected MP/MPL/MFT(2) actuators!

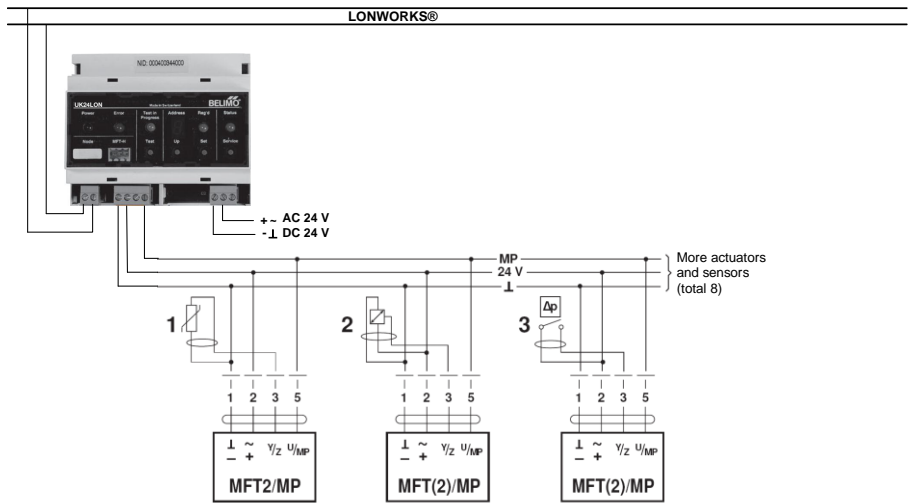

Connection of the MP-Bus

- The network consists of a 3-pin connection (MP communication and 24 V supply).
- Possibility of connecting a maximum of 8 MP/MPL/MFT(2) actuators per network.
- Neither a special cable nor terminating resistors are required.
- The signal conductor lengths (for calculation, see below) are limited:
 - by the sum of the signal conductor data of the connected MP/MPL/MFT(2) actuators,
 - by the type of supply (AC 24 V via the bus or DC 24 V via the bus),
 - by the signal conductor cross-section.

With AC 24 V supply:
 Maximum signal conductor length

L = max. cable length [m]

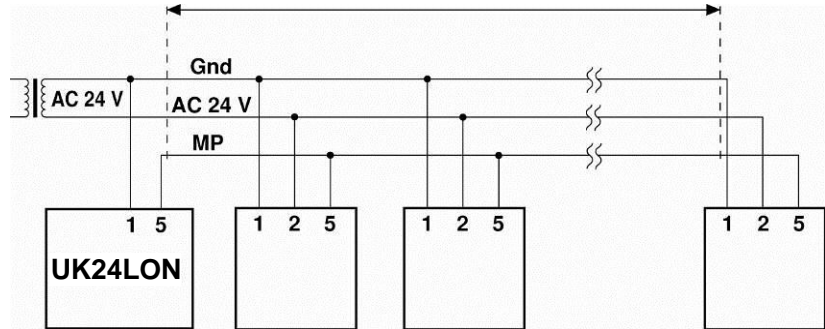

With AC 24 V supply:
 Total dimensioning
 MP/MPL/MFT(2) actuators [VA]

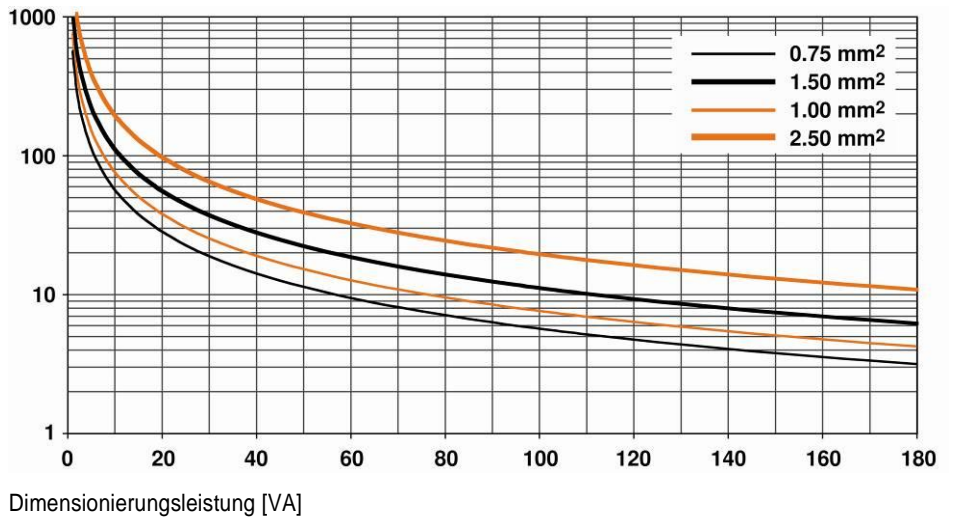

Electrical installation

**With AC 24 V supply:
Calculation of the maximum signal
conductor lengths**

The power ratings [VA] of the MP/MPL/MFT(2) actuators used are to be added, and the corresponding signal conductor lengths are to be read from the diagram.

To be read out from the mass of curves:	
For cables with wire-Ø [mm²]	Cable length [m]
0.75	29
1.00	35
1.50	50
2.50	90

Example:

The following is connected to the MP-Bus: 1 pc. NM24A-MP, 1 pc. SM24A-MP, 1 pc. LMV-D2-MP... and 1 pc. NV24A-MP

Total power rating: 5.5 VA + 6 VA + 5 VA + 5 VA = 21.5 VA

**With local supply AC 24 V (on site):
Maximum signal conductor length**

The signal conductor lengths can be significantly increased if the actuators are supplied with AC 24 V locally via a separate transformer. The signal conductor lengths indicated in the table apply regardless of the performance data of the actuators connected to the UK24LON.

Wire-Ø [mm²]	L = max. cable length [m]
0.75	800
1.00	
1.50	
2.50	

**With DC 24 V supply:
Maximum signal conductor length**

L = max. cable length [m]

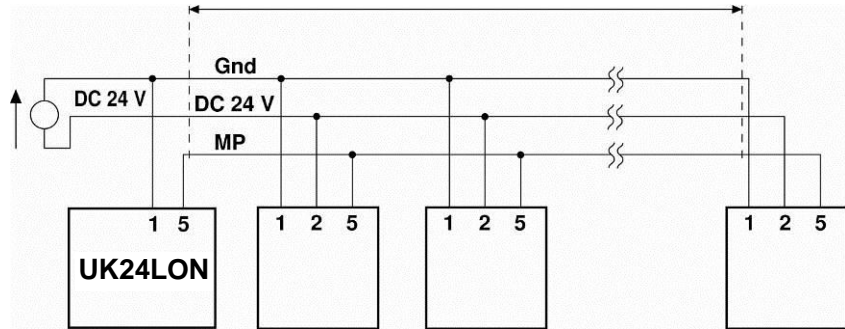

**With DC 24 V supply:
Total power consumption
MP/MPL/MFT(2) actuators [W]**

Cable length vs. wire sizing power applies to DC supply (minimum supply voltage DC 24.0 V)

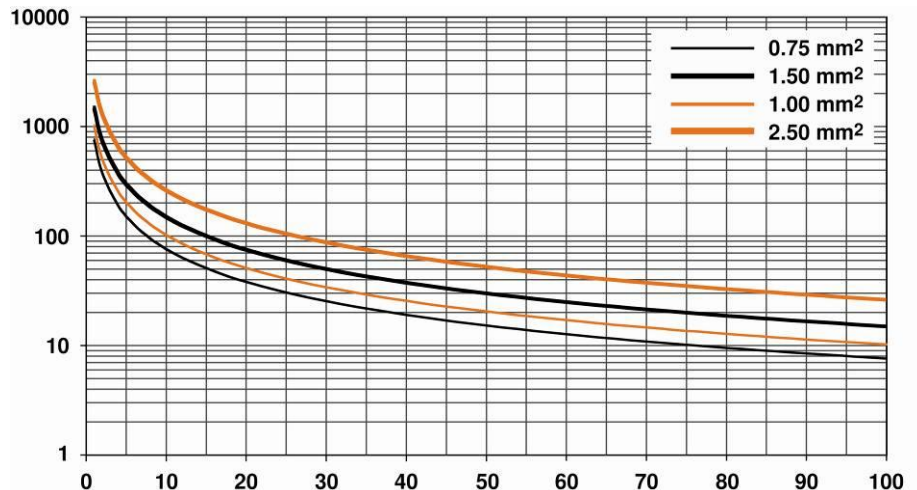

Note

Cable length vs. wire sizing power applies to DC supply (minimum supply voltage DC 24 V)

Electrical installation

With DC 24 V supply: Calculation of the maximum signal conductor lengths

The power consumption [W] of the MP/MPL/MFT(2) actuators used is to be added, and the corresponding signal conductor lengths are to be read from the diagram.

Example:

The following is connected to the MP-Bus: 1 pc. NM24A-MP, 1 pc. SM24A-MP, 1 pc. LMV-D2-MP, and 1 pc. NV24A-MP

Total power rating $3.5 \text{ W} + 4 \text{ W} + 3 \text{ W} + 3 \text{ W} = 13.5 \text{ W}$

To be read out from the mass of curves:

For cables with wire-Ø [mm ²]	Cable length [m]
0.75	55
1.00	75
1.50	110
2.50	190

Dimensions

Dimensional drawings [mm]

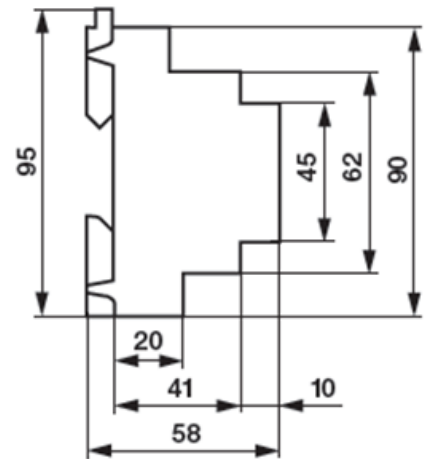
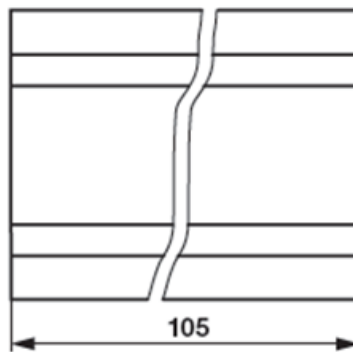

Operation

Legend

- (1) Power LED
- (2) Error LED
- (3) Test in progress LED
- (4) MP address display
- (5) Registered actuator LED
- (6) Individual Neuron ID
- (7) Status LED function according to Echelon Guidelines
- (8) Service button for commissioning with LONWORKS®
- (9) Unit power supply AC or DV 24V
- (10) Set-button for MP addressing
- (11) Up-button for selection of the MP-address
- (12) Start test button
- (13) Connection MP-Bus
- (14) Connection MFT-parameterisation tools
- (15) Connection LONWORKS®
- (16) Node label

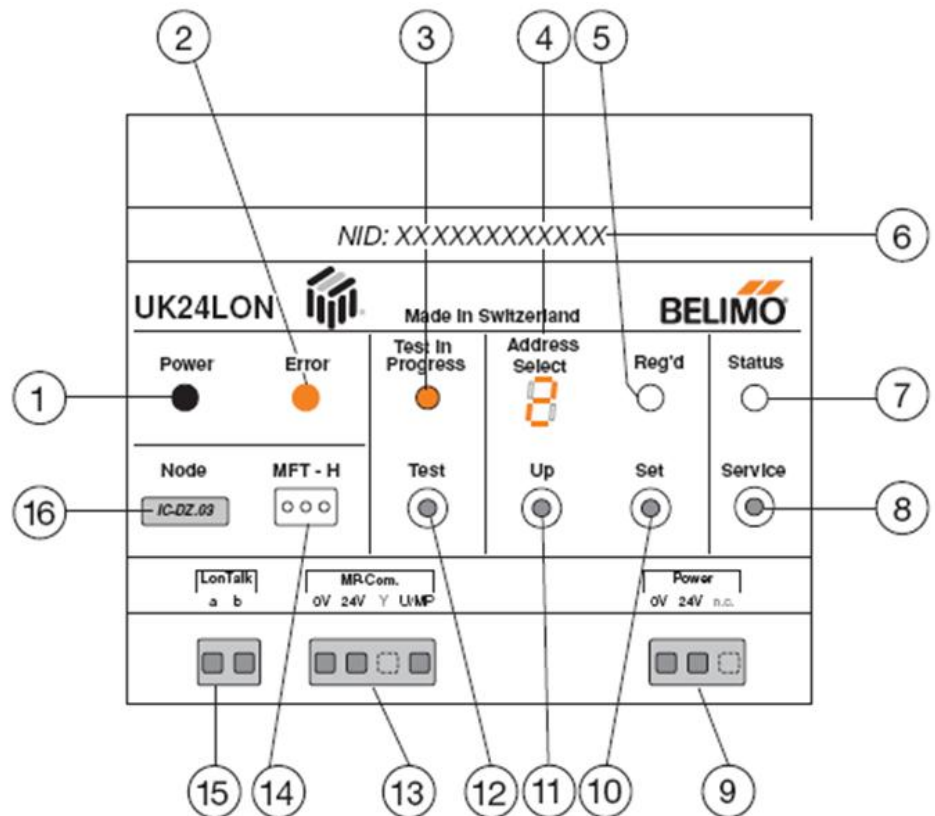

The illustration shows the controls on the front panel of the device.

Manual addressing of actuators

All required actuators must be connected first.

Use the Up (**11**) button to select the address to be issued. The actual address will be shown on the display (**4**)

Use the Set button (**10**) to start the addressing process (hold for at least 2 seconds). The **Reg'd (5)** LED starts flashing slowly to indicate that the process is in progress.

Within the next 10 minutes the MP-actuator being addressed must be reset at the actuator itself. The UK24LON unit will then be able to recognize and address the actuator. This status is indicated by fast flashing of the **Reg'd LED (5)**.

As soon as addressing of the actuator has been completed the **Reg'd LED (5)** gives a steady light. This also indicates that the MP address has been successfully stored in the reference table of the UK24LON unit.

Notes on addressing

If none of the actuators has been reset within 10 minutes of the addressing process being initiated, the process will be discontinued. The reference table remains unchanged and the **Reg'd LED (5)** stops flashing.

If an address is issued that has already been assigned to another actuator the latter is automatically de-addressed first before the new actuator is addressed.

If a mistake is made in initiating addressing, the process can be stopped by briefly pressing the **Set (10)** button.

Normal data traffic on the MP network is interrupted while addressing is in progress.

Operation

- Manual de-addressing of MP actuators** All required actuators must be connected first.
- Use the **Up (11)** button to select the address to be deleted. The actual address will be shown on the display **(4)**.
- Use the **Set (10)** button to start the de-addressing process (hold for at least 2 seconds). The **Reg'd LED (5)** starts flashing slowly to indicate that the process is in progress.
- Press the **Set (10)** button a second time and hold it depressed until the **Reg'd LED (5)** starts fast flashing.
- As soon as de-addressing of the actuator has been completed, i.e. deleted from the reference table and set to the address "PP", the **Reg'd LED (5)** goes dark **(5)**.
- Notes on de-addressing** If, after de-addressing has been initiated, the **Set** button **(10)** is not pressed a second time, then the de-addressing process will be discontinued. The reference table remains unchanged and the **Reg'd LED (5)** stops flashing.
- If an address is issued that has already been assigned to another MP-actuator the latter is automatically de-addressed first before the new MP-actuator is addressed.
- If a mistake is made in initiating addressing, the process can be stopped by briefly pressing the **Set** button **(10)**.
- Normal data traffic on the MP network is interrupted while addressing is in progress.
- Testing the MP-actuators** Use the **Up** button **(11)** to select the address to be tested. The actual address will be shown on the display.
- Now start the test with the **Test** button **(12)**. The **Test in progress LED (3)** gives a steady light to indicate that the process is in progress. The actuator opens fully and then closes fully.
- When the test has been completed the **Test in progress LED (3)** goes out and the actuator returns to its last reference position.
- Notes on testing** If a mistake is made in initiating testing, the process cannot be stopped. Normal data traffic with the other actuators on the MP network is continued while testing is in progress.
- By holding the **Test** button **(12)** depressed for more than 2 seconds all addressed and responding actuators can be tested simultaneously.
- No mechanical testing of actuators can be initiated at addresses that have either not been registered or are incorrect.
- Automatic standby mode (darkening of the display)** The displays and operating controls of the UK24LON unit are deactivated automatically when they are not being used in order to save energy and to avoid accidental (mal-) operation. Automatic deactivation occurs approximately 2 minutes after the last time an operating control is used provided there is no mechanical testing or addressing in progress and no errors are being displayed. The unit can be reactivated by pressing the **Up** button **(11)** (for at least 2 s). It will not be possible to perform a mechanical actuator test or addressing/de-addressing until this has been done.

Error & Status indication

- 1. Permanently lit error LED** The UK24LON unit can detect communications faults on the MP network. They are indicated by the **Error LED (2)** lighting up and the appropriate address being displayed. If more than one address is affected the lowest one will be displayed. The display can then be scrolled with the **Up** button **(11)**. The UK24LON gateway cannot change to standby mode as long as an error is being displayed.
- 2. Flashing error LED** A flashing LED **Error (2)** and simultaneous display of the MP addresses indicates a mechanical fault of the corresponding MP actuator. (The fault can be diagnosed with the PC-Tool). The flashing **Error LED (2)** means that the MP communication between UK24LON and the corresponding actuator is OK.
- LON status indication** The **Status LED (7)** behaves as indicated in the Echelon Guidelines:
- Dark: The UK24LON gateway is ready for service and connected to the LONWORKS® network.
 - Flashing at 2-second intervals: The UK24LON gateway is ready for service but not connected to the LONWORKS® network.
 - Steady light: The UK24LON gateway has not been loaded with application software.
 - Other flashing: There is a fault in the UK24LON gateway.
- Automatic scanning of the MP network** As soon as the UK24LON gateway is powered up it starts scanning the MP network automatically. All eight MP addresses are interrogated cyclically to see whether there is an actuator available to respond. The results are compared against a reference table stored in the UK24LON gateway. If an actuator responds from an MP address that is not assigned in the reference table it is automatically inserted into the table. If an actuator already assigned in the reference table fails to respond an error alarm is initiated but the reference table is not altered in any way. The MP-actuators can be pre-addressed so that they are recognized automatically when they are connected to the MP network.

Functional Profile

Functional Profile by LONMARK®

The UK24LON Gateway converts the digital communications processes of the MP-Bus to standard LONMARK® network variables.

Node Object #0

Node Object contains the functions Object Status/Object Request.

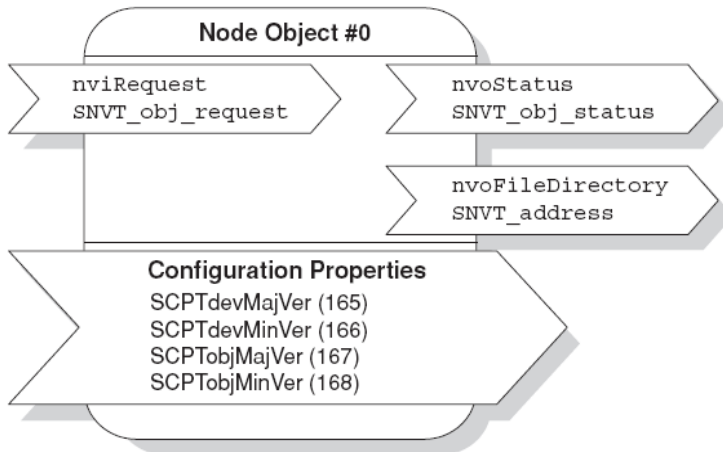

nviRequest SNVT_obj_request

Input variable, demands the status of a specific object in the node.

nvoStatus SNVT_obj_status

Output variable, gives the actual status of a specific object in the node.

nvoFileDirectory SNVT_address

Output variable, indicates information in the address area of the Neuron chip.

Damper Actuator Object #8110

The actuator object shows the functions of the MP-actuators on the LONWORKS® network side. The UK24LON unit implements 8 of these objects (one for each MP-actuator). The Damper Actuator Object 0 corresponds to MP-Address 1.

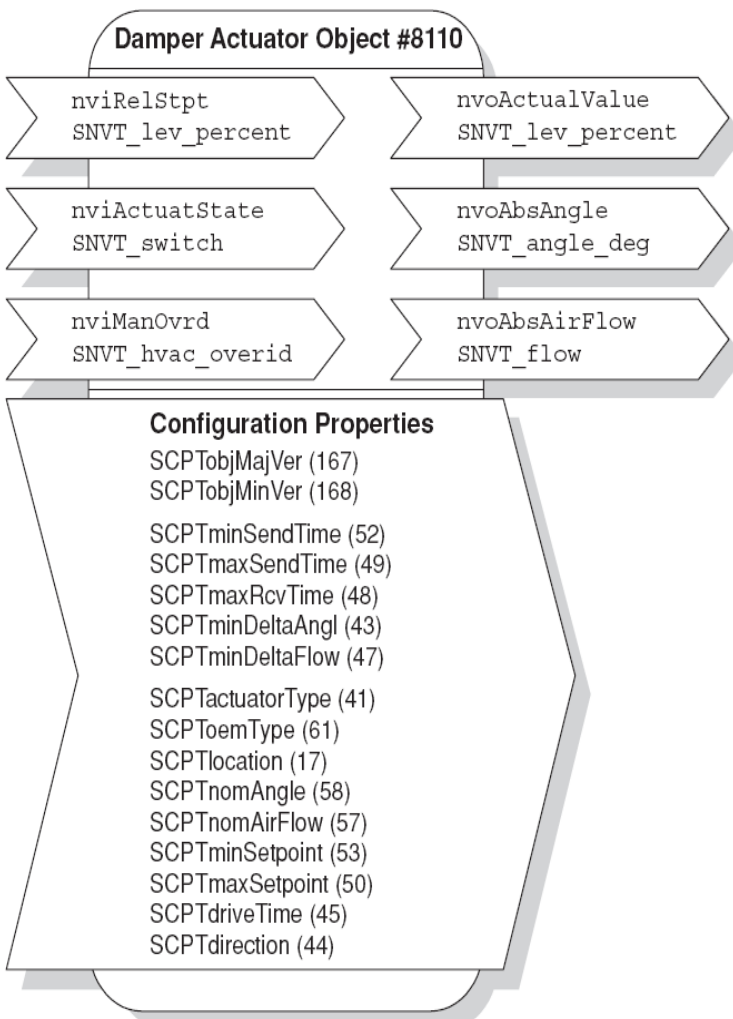

nviRelStpt SNVT_lev_percent

This input variable gives the actuator its reference position or setpoint. The variable is normally linked to the output variable of an HVAC controller.

nviActuatState SNVT_switch

This input variable gives the actuator a preset position. Note on priority: whichever variable, (nviActuatState or nviRelStpt), was last active takes priority.

nviManOvrd SNVT_hvac_overid

These input variables can be used to manually override the actuator into a particular position (0...100%) or a certain volume (in % of V'Nom). If the manual override (nviManOvrd) is in HVO_OFF status, the network variables nviRelStpt or nviActuatState are active.

nvoActualValue SNVT_lev_percent

This output variable shows the actual position of the actuator.

nvoAbsAngle SNVT_angle_deg

This output variable shows the actual angle of rotation, respectively stroke of the actuator and can be used for indicating position or for servicing purposes.

nvoAbsAirFlow SNVT_flow

This output variable shows the actual volumetric flow through the appropriate box and can be used for control and indicating purposes (MP-VAV and EPIV only).

Functional Profile

Open Loop Sensor Object #1

One sensor can be connected to each MP actuator. To MFT-actuators, an active sensor (e.g. with a DC 0...10 V output) or a switching contact can get connected. For MFT2/ MP-actuators it is possible to connect additionally passive sensors (e.g. PT1000). The measured sensor values are transferred to the LonWORKS® network by the Open Loop Sensor Object. This object is implemented 8 times in the UK24LON gateway. The Sensor Object 0 corresponds to the sensor connected on address MP1.

MPL-actuators do not support sensor detection.

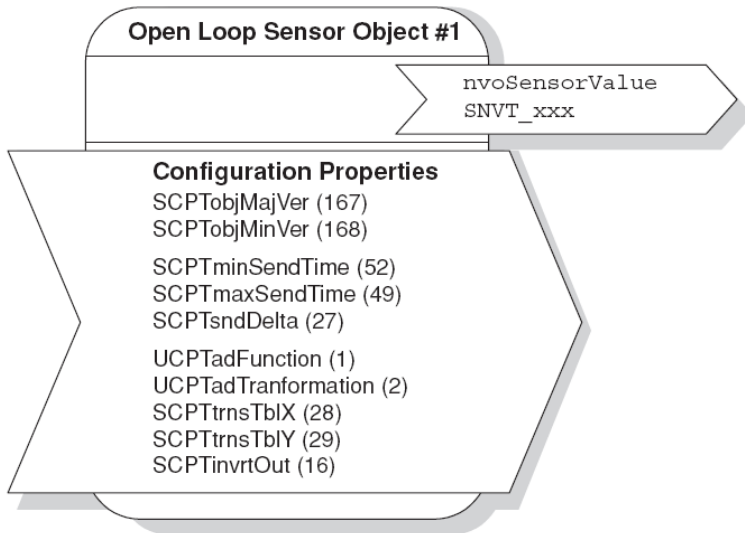

nvoSensorValue SNVT_xxx

This output variable shows the actual sensor value. Depending on the connected sensor, the output variable can be configured via the sensor plug-in and specifically adapted to the system.

The SNVT_xxx can be configured as follows:

SNVT_temp_p	SNVT_lev_percent	SNVT_lux
SNVT_temp	SNVT_abs_humidity	SNVT_press_p
SNVT_switch	SNVT_enthalpy	SNVT_smo_obscur
SNVT_flow	SNVT_ppm	SNVT_power
SNVT_flow_p	SNVT_rpm	SNVT_elec_kwh

Supported SNVT per actuator

MP-Actuator

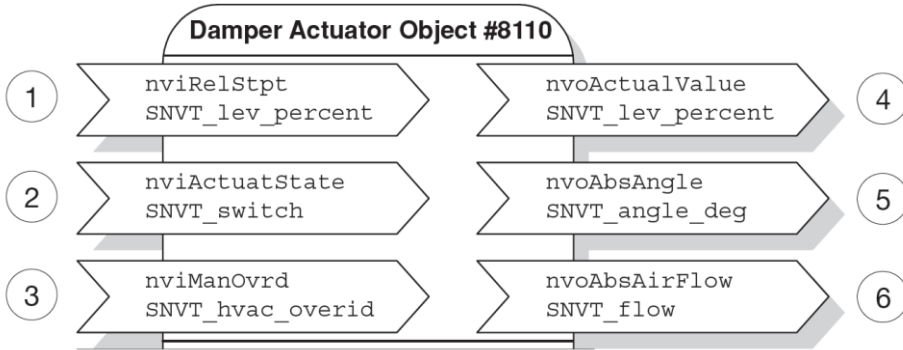

- 1) **nviRelStpt:** Setpoint for actuator position (0...100% angle of rotation resp. stroke).
- 2) **nviActuatState:** Setpoint of the damper position in accordance with the selected position
- 3) **nviManOvrd:** See table "Overview SNVT-Functions nviManOvrd".
- 4) **nvoActualValue:** Actual value for actuator position (0...100% angle of rotation resp. stroke).
- 5) **nvoAbsAngle:** This output shows the absolute value of the actuator in angle of degrees (°), respectively stroke in mm at linear and globe valve actuators.
- 6) **nvoAbsAirFlow:** SNVT is not supported

MPL-Actuator

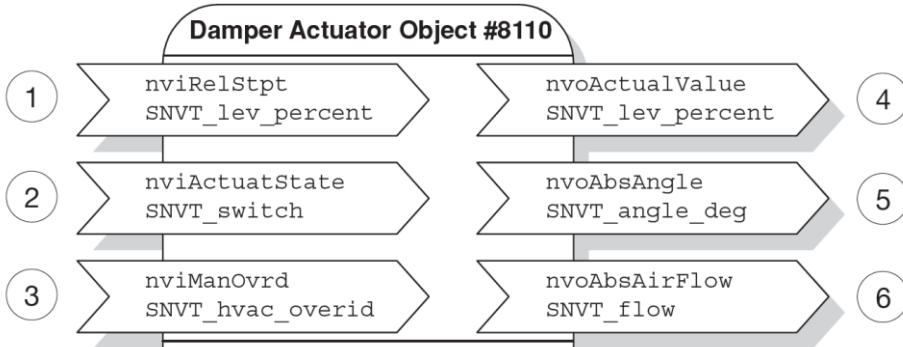

- 1) **nviRelStpt:** Setpoint for actuator position (0...100%) angle of rotation
- 2) **nviActuatState:** SNVT is not supported.
- 3) **nviManOvrd:** See table "Overview SNVT-Functions nviManOvrd".
- 4) **nvoActualValue:** Actual value for actuator position (0...100%) angle of rotation.
- 5) **nvoAbsAngle:** SNVT is not supported
- 6) **nvoAbsAirFlow:** SNVT is not supported

Min and Max settings are not supported on MPL-actuators.

Supported SNVT per actuator

VAV-Controller for volumetric flow applications

EPIV

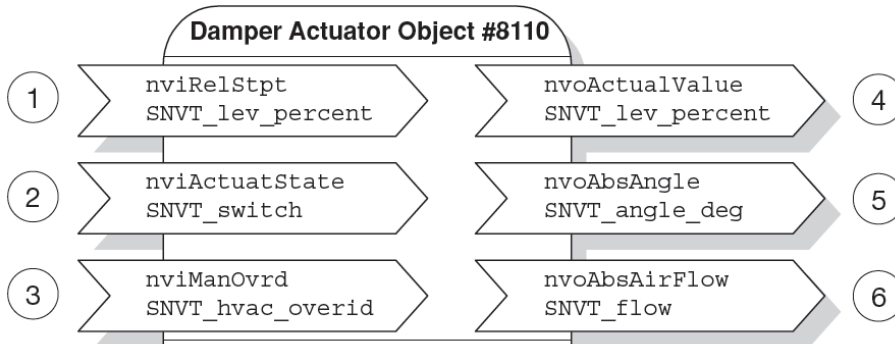

- 1) **nviRelStpt:** Setpoint for the VAV-controller of the VAV-unit or the EPIV (0...100% = Vmin-Vmax).
- 2) **nviActuatState:** Setpoint of the volumetric flow in accordance with the selected position
- 3) **nviManOvrd:** See table "Overview SNVT-Functions nviManOvrd".
- 4) **nvoActualValue:** Actual value of volumetric flow (0...100% nominal volumetric flow of the VAV unit) or the volumetric flow of the EPIV.
- 5) **nvoAbsAngle:** Displays the current actuator position [angle of rotation in degrees of angle (°)].
- 6) **nvoAbsAirFlow:** Displays the current volumetric flow in l/s.

Supported SNVT per actuator

VAV-Controller for duct- and room pressure control
(VRP-M V3.x)

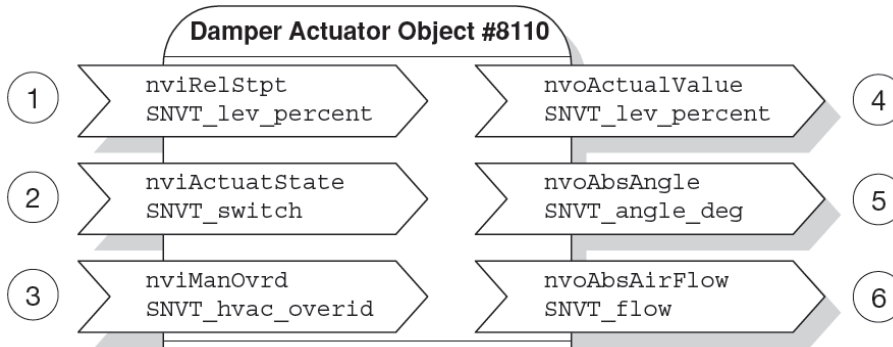
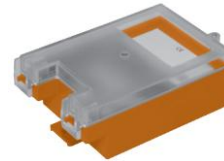

- 1) **nviRelStpt:** Setpoint for pressure control (0...100% = Pmin-Pmax).
- 2) **nviActuatState:** Setpoint of the pressure range in %, in accordance with the selected position
- 3) **nviManOvrd:** See table "Overview SNVT-Functions nviManOvrd".
- 4) **nvoActualValue:** Actual value of the pressure (0...100% von P'Nom)
- 7) **nvoAbsAngle:** Displays the current actuator position [angle of rotation in degrees of angle (°)].
- 5) **nvoAbsAirFlow:** Displays the actual volume flow in l/s. Value has to get multiplied with factor 3.6 to display Pa.

Overview network variables

VRP-M V3.x

Damper Actuator Object

Network variable	Description	Comments
SCPTnomAirFlow	P'Nom in l/s	Value has to get multiplied with factor 3.6 to display Pa.
SCPTmaxSetpoint	Display and setting maximum Pressure in % of P'Nom	Display in % of P'Nom
SCPTminSetpoint	Display and setting minimum Pressure in % of P'Nom	Display in % of P'Nom
nviRelStpt SNVT_lev_percent	Control 0 %...100%	Corresponds to control range P'Min...P'Max
nvoAbsAirFlow SNVT_flow	Actual flow in l/s	Value has to get multiplied with factor 3.6 to display Pa.
nvoActualValue SNVT_lev_percent	Feedback 0...100%	Display in % of P'Nom
nvoAbsAngle SNVT_angle_deg	Damper position in 0...90°	

Sensor Object

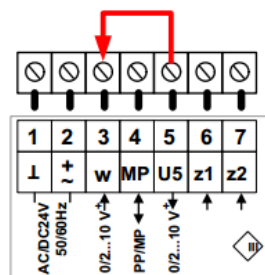

By wiring input 3 [w] of the VRP-M to the actual pressure signal [U5], it is possible to display the pressure measured by the sensor (0...10 V = 0...P'Nom) directly as a Pa value in the LON system with the open loop sensor object #1.

Network variable	Description	Comments
SCPTpress_p	0...P'Nom Sensor scaling: 0V= 0Pa / 10V = P'Nom	Caution: The mode setting on the VRP-M must match the sensor signal

Supported SNVT per actuator

Override control with nviManOvrD

	HVO_OFF Standard setting Last value of nviRelStpt or nviActuatState active	HVO_POSITION Override position 0-100%	HVO_FLOW_VALUE Flow in l/s adjustable	HVO_FLOW_PERCENT Flow in % to VNom resp. pressure in % to PNom adjustable	HVO_OPEN Override Open	HVO_CLOSE Override Closed	HVO_MINIMUM On the actuator set Min position, resp. V/Min	HVO_MAXIMUM On the actuator set Max Position, resp. V/Max
MP-Actuator	•	•			•	•	•	•
MPL-Actuator	•	•			•	•		
VAV-Controller	•	•	•	•	•	•	•	•
VRP-M	•	•			•	•	•	•
EPIV	•	•		•	•	•	•	•

Example of override control with the SNVT nviManOvrD in VAV controllers

Functions:

- HVO_OFF: Temperature controller set points are active
- HVO_OPEN: All VAV units are fully open (e.g. flushing operation or night cooling)
- HVO_CLOSE: All VAV units are fully closed (system closed when the air conditioning system is switched off)

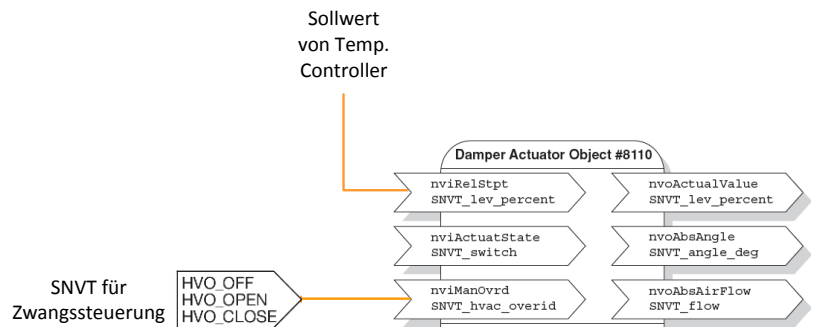

Connecting the PC-Tool for parameterizing of the MP-actuators

With the Belimo PC-Tool it is possible to scan the MP-network, address actuators and set specific parameters of the actuators (e.g. runtime).

The PC-Tool can be connected to the 3-pole plug socket of the UK24LON, by using the connection cable ZK4-GEN and the ZIP-USB-MP, to obtain direct access to the appropriate actuator. During access the UK24LON unit signals that communication between PC-Tool and actuator is in progress by means of the letter "H" on the display.

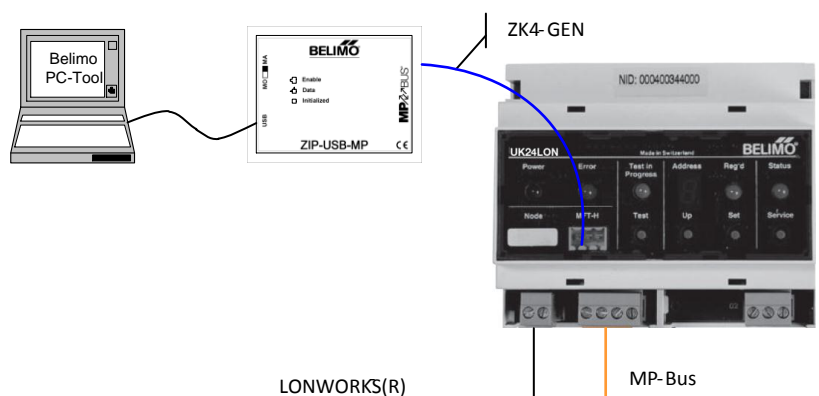

Version overview**Firmware V3.11** New Function

- Support of MPL-actuators

Firmware V3.10 New Function

- Hardware change of the LON-Chip to FT3150 / The application do not run with V3.2 or older.
- The absolute Volume (nvoAbsAirFlow) shows the correct flow on EPIV nodes. There is no conversion required anymore.

Firmware V3.02 • The application runs on UK24LON with FT3120. Do not load to V3.10 or newer.

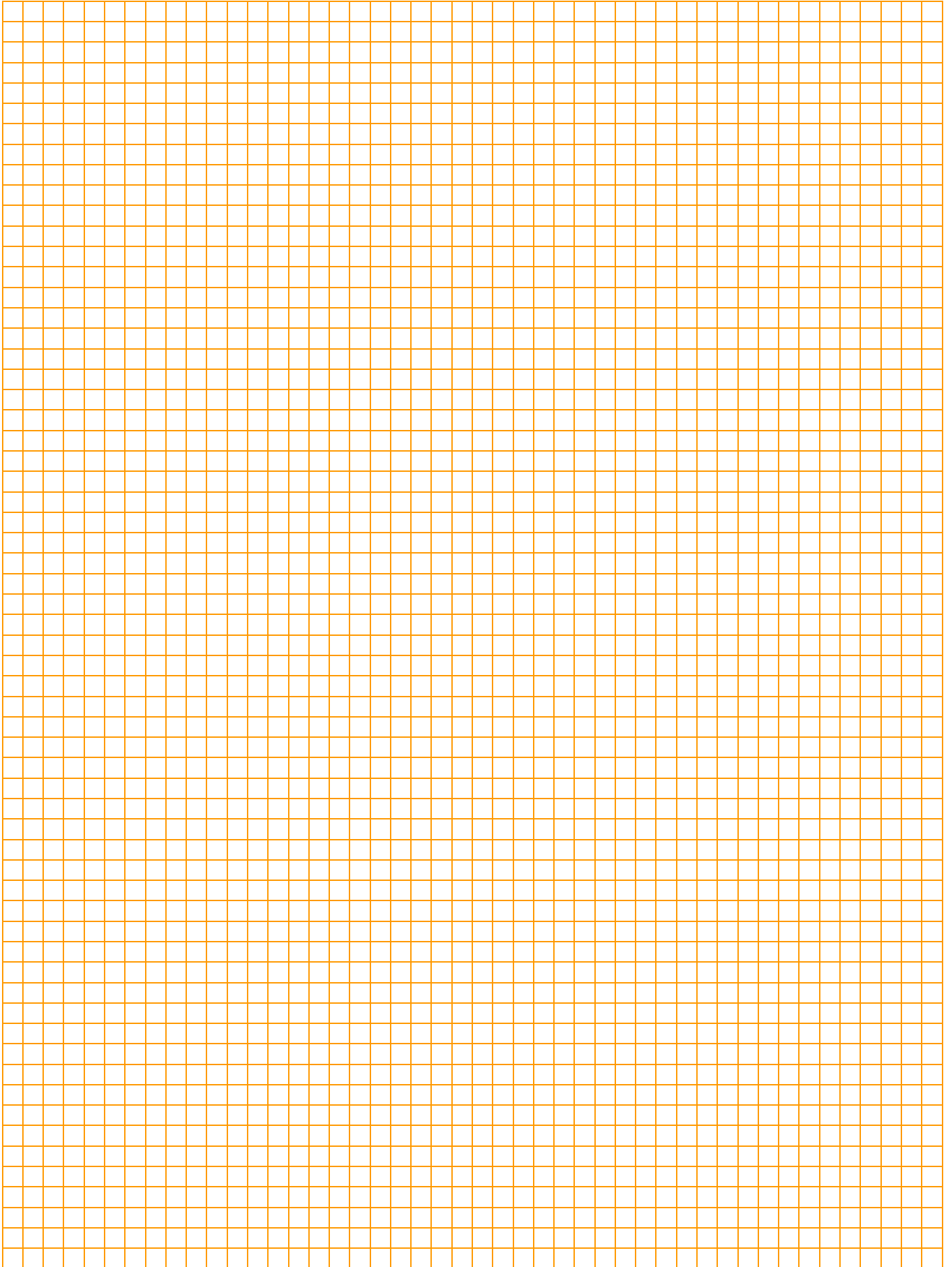

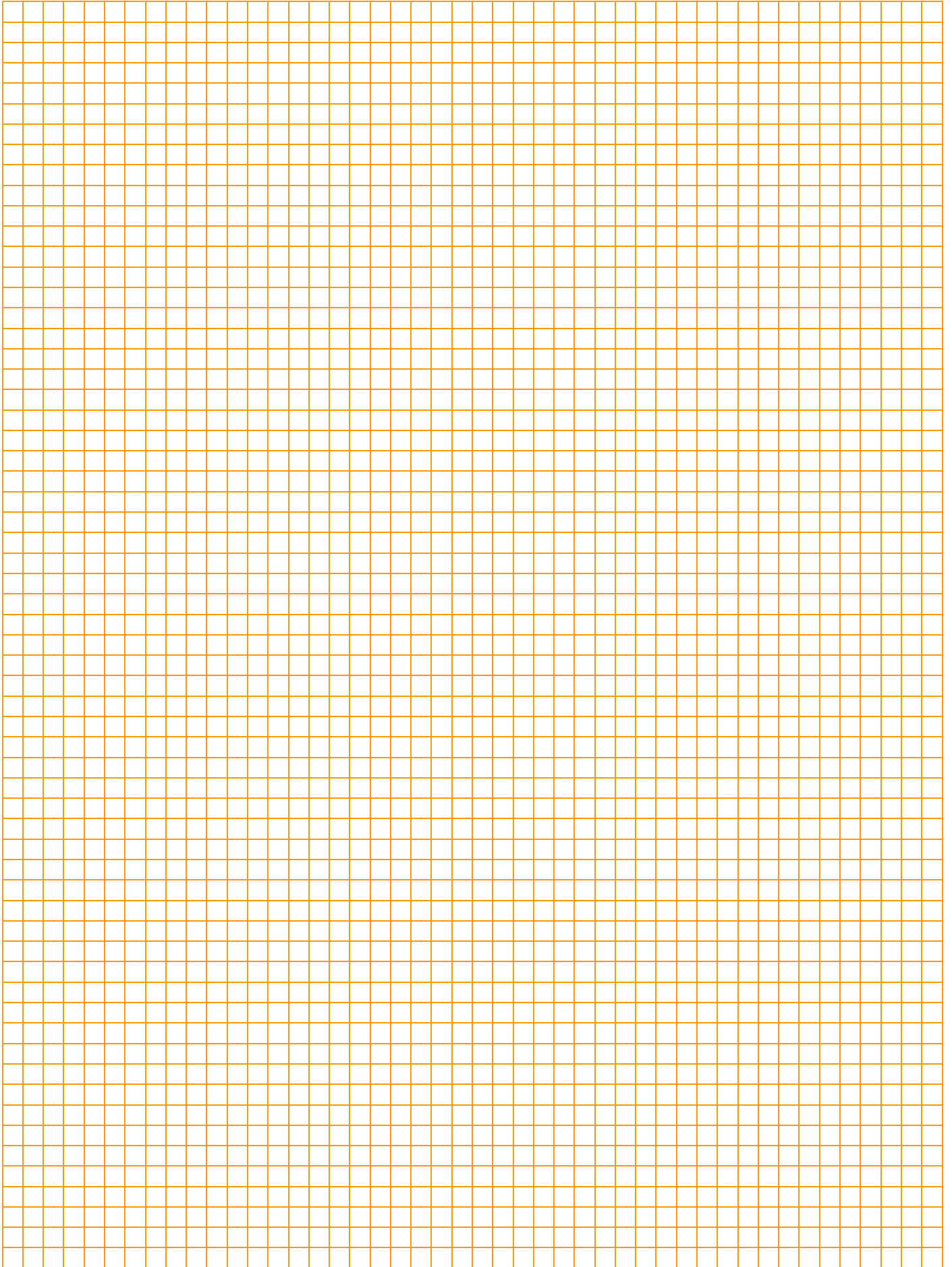

All-inclusive.



5-year warranty



On site around the globe



A complete range of products from one source



Tested quality



Short delivery times



Comprehensive support

Headquarters

BELIMO Holding AG
Brunnenbachstrasse 1
CH-8340 Hinwil
Tel. +41 43 843 61 11
Fax +41 43 843 62 68
info@belimo.ch
www.belimo.com

Subsidiaries, Representatives and Agencies

Albania	Cameroon	Japan	Qatar
Algeria	Canada	Jordan	Romania
Argentina	Central America	Kazakhstan	Russia
Australia	Chile	Korea	Saudi Arabia
Austria	China	Kuwait	Serbia
Bahrain	Croatia	Latvia	Singapore
Belarus	Cyprus	Lebanon	Slovakia
Belgium	Czech Republic	Libya	Slovenia
Bosnia	Denmark	Lithuania	South Africa
Brazil	Egypt	Luxembourg	Spain
Bulgaria	Estonia	Macedonia	Sri Lanka
	Finland	Malaysia	Sweden
	France	Malta	Switzerland
	Georgia	Mexico	Taiwan
	Germany	Moldova	Thailand
	Greece	Montenegro	Tunisia
	Great Britain	Morocco	Turkey
	Hong Kong	Netherlands	United Arab Emirates
	Hungary	New Zealand	Ukraine
	Iceland	Norway	United States of America
	India	Oman	Vietnam
	Indonesia	Pakistan	
	Ireland	Philippines	
	Israel	Poland	
	Italy	Portugal	

Belimo worldwide: www.belimo.com

BELIMO[®]