

Belimo Gateway MP to EIB/Konnex UK24EIB

Manufactured and certified by Woertz as a Konnex Member

Table of Contents	Page
Product overview	2
Technical data	3
Safety notes	3
Product features	3
Mounting and commissioning	4
Electrical installation (connecting actuators, sensors, MP-Bus, conductor lengths)	4
Dimensions	6
Configuration of UK24EIB with ETS Software	7
General configuration for MFT(2)/MP actuators and VAV-Compact controllers xMV-D2-MP	8
Configuration of the error mask	9
Configuring the connected sensor with MFT2/MP actuators and VAV-Compact controllers xMV-D2-MP	10
Configuration of the connected sensor in case of MFT(2)/MP actuators and VAV-Compact controllers xMV-D2-MP	
Selected sensor: Active temperature sensor	11
Selected sensor: Humidity sensor	12
Selected sensor: Brightness sensor	13
Configuration of the connected sensor in case of MFT actuators	14
EIB-relevant functions for VAV-Compact xMV-D2-MP controllers and MFT(2)/MP actuators	15
UK24EIB Legend for operating controls	18
Operation, Characteristics of the UK24LON unit	18
Connecting parameterizing tools for the MFT(2)/MP actuators	20

Product overview

Gateway MP UK24EIB

**Suitable MFT(2)/MP actuators** Damper actuators with or without safety function

MP-VAV devices



Actuators for characterised control ball valves with or without spring-return function



Actuators for globe valves with or without spring-return function



Actuators for butterfly valves



Gateway MP to KNX systems. The UK24EIB Gateway Module is KNX-certified. Belimo actuators with an MP-Bus capability can be connected on the MP-Bus side.

- MP-Bus / KNX interface
- MFT(2)/MP actuators (with MP-Bus capability) can be connected to an KNX system through a UK24EIB module
- Up to 8 actuators can be connected
- KNX-certified



Technical data

Electrical data	Nominal voltage	AC 24 V, 50/60 Hz / DC 24 V	
	Nominal voltage range	AC 19.2 ... 28.8 V / DC 21.6 ... 28.8 V	
	For wire sizing	2 VA (without MFT(2)/MP actuators connected)	
	Connections	EIB/KNX:	Push-screw terminals, 2-pole
		Power:	Push-screw terminals, 3-pole
		MFT(2)/MP actuators:	Push-screw terminals, 4-pole (all terminals for 2 x 1.5 mm ²)
		MFT-H:	Plug socket, 3-pole for PC-Tool (MFT-P) and ZIP-RS232
Medium	Twisted pair		
Configuration software	Adjustable with ETS 2 or higher	– Actuator type – Definition of the sensors connected to the MFT(2)/MP actuators	
Functional data	Actuators supported	All Belimo xMV-D2-MP, MFT(2)/MP actuators	
	Number of actuators	8 maximum	
	Actuator communication	Belimo MP-Bus, Master-Slave system, 1200 Baud	
	Maximum MP conductor length	Depends on the number of MFT(2)/MP actuators connected, type of actuator, type of power supply and conductor cross section. For details see diagrams on page 5/6	
	EIB conductor lengths and transmission media	According to EIB guidelines	
Safety	Protection class	III Safety extra-low voltage	
	Degree of protection	IP20	
	EMC	CE according to 89/336/EEC	
	Ambient temperature range	–5 ... +50 °C	
Mounting / Dimensions / Weight	Mounting	35 mm DIN rail	
	Abmessungen	See page 6	
	Weight	Approx. 200 g	

Safety notes



- The device does not contain any parts that can be replaced or repaired by the user.
- It may only be installed by suitably trained personnel.
- Do not power-up until the whole system (UK24EIB module, actuators, power supply) has all been fully connected.

Product features

Mode of operation	Actuators can be controlled digitally through the UK24EIB Gateway Module over an MP-Bus system and provide a feedback signal of their actual operating position. In the UK24EIB module the digital information for control and feedback is converted into KNX messages so that the functions of the actuators can be input directly into an KNX System.
Sensor linking	One sensor can be connected to each MFT(2)/MP actuator. The sensor can be of the passive resistance type (Pt1000, Ni1000 or NTC), of the active type (DC 0 ... 10 V output) or a switching contact. This provides a simple means of digitising the analogue signals from the sensors with the Belimo actuator so that they can be passed on to the EIB system via the UK24EIB module.

Mounting and commissioning

Installation and wiring

The module is suitable for mounting on a 35 mm top-hat rail conforming to EN 60715. Wiring is by means of push-screw terminals.

Commissioning and parameterising the UK24EIB module and actuators

For commissioning purposes an application program suitable for the particular use must be downloaded to the module (via EIB/ETS).
The actuators and sensors being used can be defined by means of ETS.
The actuators can be parameterised by means of a Belimo PC-Tool or an MFT-H hand-held parameter assignment device. There is a 3-pole plug on the front of the UK24EIB for this purpose.

Electrical installation

Wiring diagram with MFT(2)/MP actuators

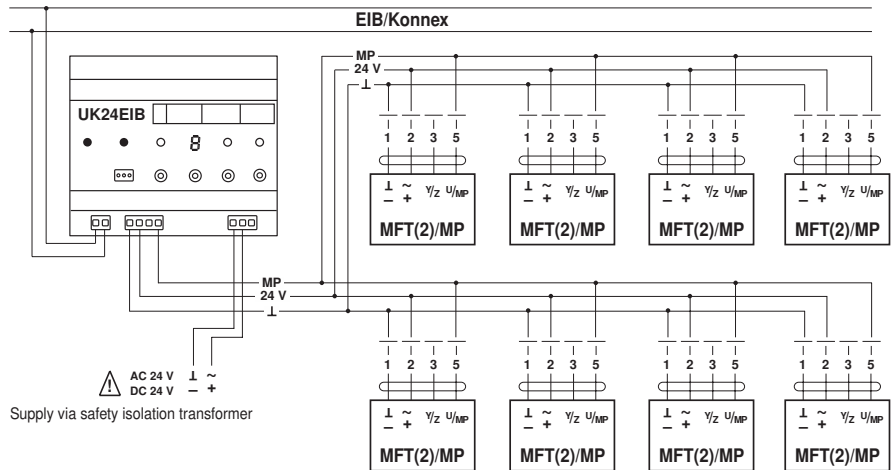

Rating the power supply
Do not forget to include the MFT(2)/MP actuators that are also connected.

Wiring diagram with sensors

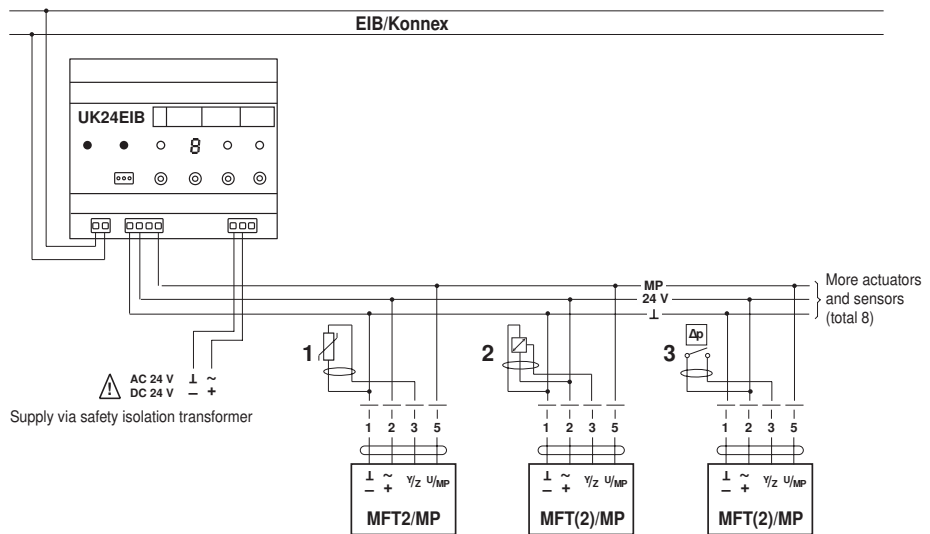

Rating the power supply
Do not forget to include the MFT(2)/MP actuators that are also connected.

One sensor can be connected to each MFT(2)/MP actuator. It can be either a passive resistance type sensor (Pt1000, Ni1000 or NTC), an active sensor (e.g. with a DC 0 ... 10 V output) or a switching contact. This provides a simple means of digitizing the analogue signal from the sensor through the actuator so that it can be passed on to EIB/Konnex via the UK24EIB unit.

1 Connecting passive sensors (Pt1000, Ni1000, NTC)

Connecting possible for MFT2/MP actuators.
Not possible for the VAV-Compact NMV-D2M actuator and for the MFT actuators.

2 Connecting active sensors (permitted input voltage range 0 ... 32 V)

3 Connecting external switches (e.g. pressure monitors)

Installation note

Ensure that proper strain relief is provided for the connecting lead.



Electrical installation

(Continued)

Connecting the MP-Bus

- The network employs a 3-pole connection (MP communication and 24 V power supply).
- Up to 8 MFT(2)/MP actuators can be connected to each network.
- No special cable or terminating resistors are needed.
- Conductor lengths are limited (see below for methods of calculation)
 - by the total power rating of the MFT(2)/MP actuators that are connected,
 - by the type of power supply (AC 24 V or DC 24 V via the bus),
 - by the cross sectional area of the conductor.

With power supply AC 24 V:
Maximum conductor length

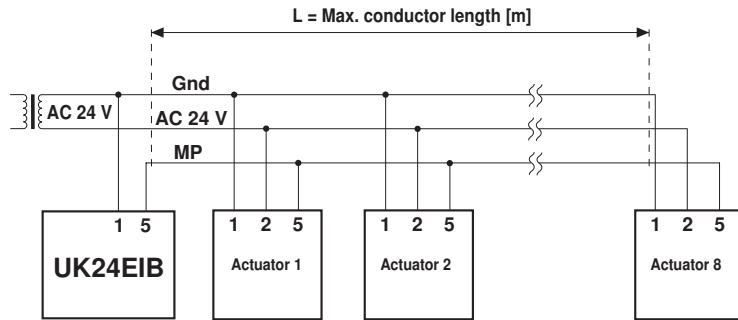

With power supply AC 24 V:
Total power rating of MFT(2)/MP actuators [VA]

Conductor length vs. Sizing rating for AC power supplies (min. transformer voltage AC 21.6 V)

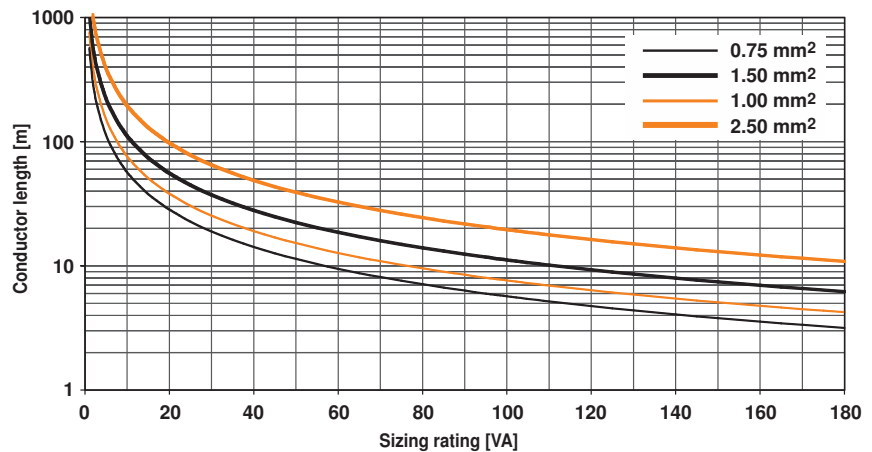

Note
In the case of the NVF24-MFT2 the sizing rating must be multiplied by 2.



With power supply AC 24 V:
Calculating maximum conductor lengths

Read off from the curves:	
Cable with core Ø [mm ²]	Cable length [m]
0.75	28
1.00	35
1.50	50
2.50	90

First add together the power ratings [VA] of the MFT(2)/MP actuators that are being used and then read off the corresponding conductor lengths from the diagram.

Example:

Connected to the MP-Bus are: 1 pc NM24A-MP, 1 pc SM24A-MP, 1 pc LMV-D2-MP... and 1 pc NV24-MFT2

Total power rating: 5.5 VA + 6 VA + 5 VA + 5 VA = 21.5 VA

With local power supply AC 24 V (local):
Maximum conductor length

Core Ø [mm ²]	L = Max. conductor length [m]
0.75	800
1.00	
1.50	
2.50	

If the actuators are fed with a local AC 24 V power supply from a separate transformer it is possible for conductor lengths to be substantially greater. Regardless of the power ratings of the actuators connected to the UK24EIB unit the conductor lengths are then as stated in the adjacent table.

Electrical installation

(Continued)

With power supply DC 24 V:
Maximum conductor length

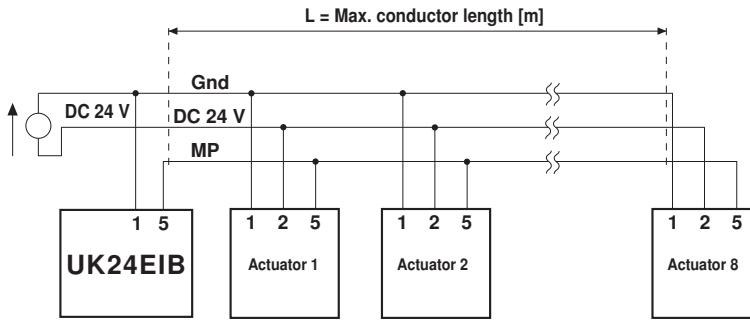

With power supply DC 24 V:
Total power rating of MFT(2)/MP actuators [W]

Conductor length vs. Active power for DC power supplies (min. supply voltage DC 24.0 V)

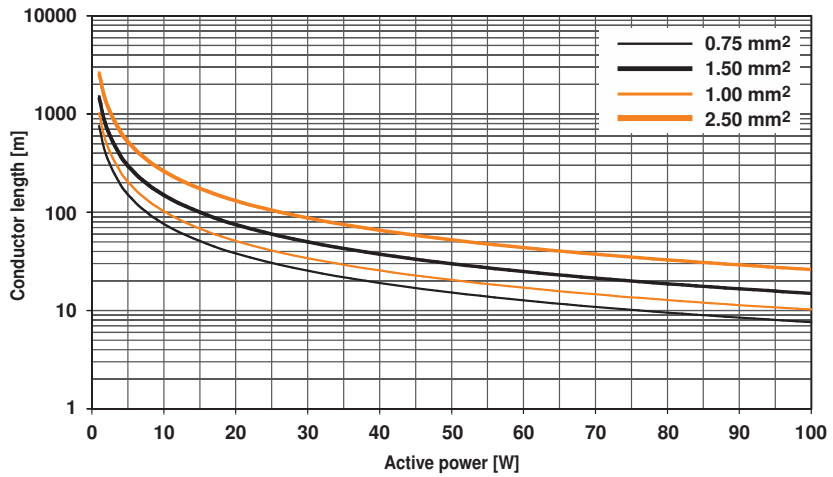

Note
Conductor length vs. Active power for DC power supplies (min. supply voltage DC 24 V).

With power supply DC 24 V:
Calculating maximum conductor lengths

First add together the power ratings [W] of the MFT(2)/MP actuators that are being used and then read off the corresponding conductor lengths from the diagram.

Read off from the curves:	
Cable with core Ø [mm²]	Cable length [m]
0.75	55
1.00	75
1.50	110
2.50	190

Example:

Connected to the MP-Bus are: 1 pc NM24A-MP, 1 pc SM24A-MP, 1 pc LMV-D2-MP... and 1 pc NV24-MFT2

Total power rating: 3.5 W + 4 W + 3 W + 3 W = 13.5 W

Dimensions [mm]

Dimensional diagrams

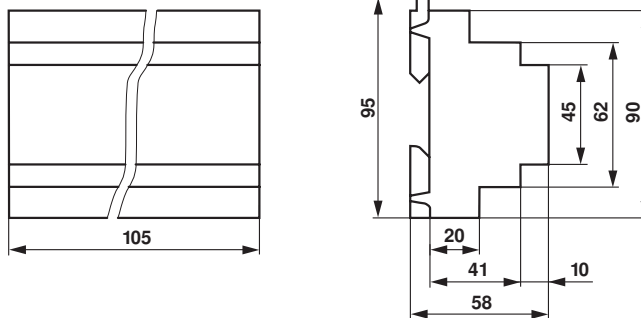

Configuration of UK24EIB with ETS Software

Configuration of the connected actuator Each MP-Bus address must be configured for the type of actuator communicating through it. The types of actuator available appear as a list:

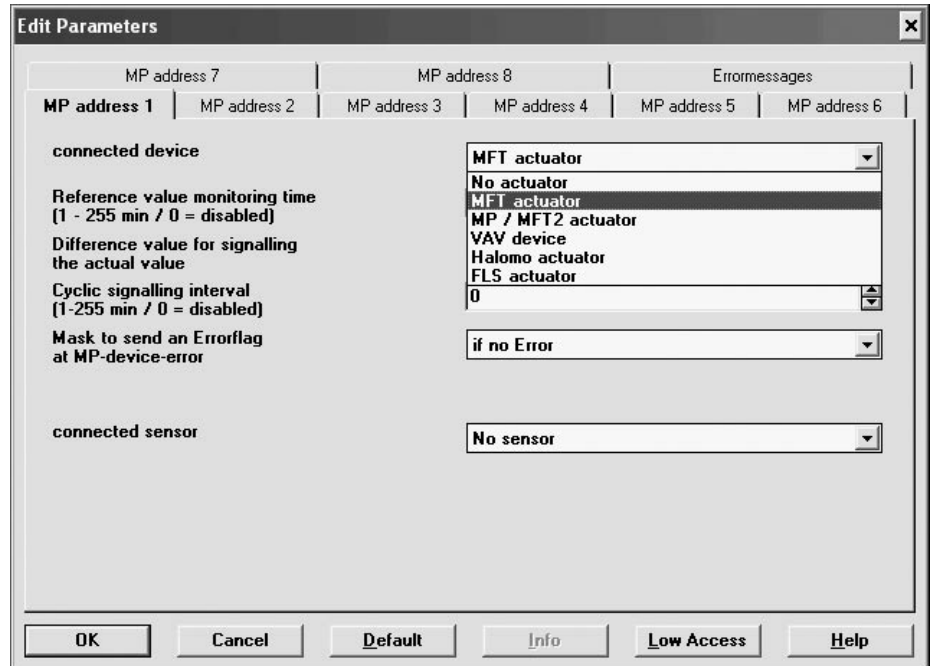

The UK24EIB continuously checks the actual physical assignment of the addresses and sets the error bit accordingly if the assignment does not correspond to the configuration. The error output can be repeated cyclically if necessary. The rate of repetition can also be configured.

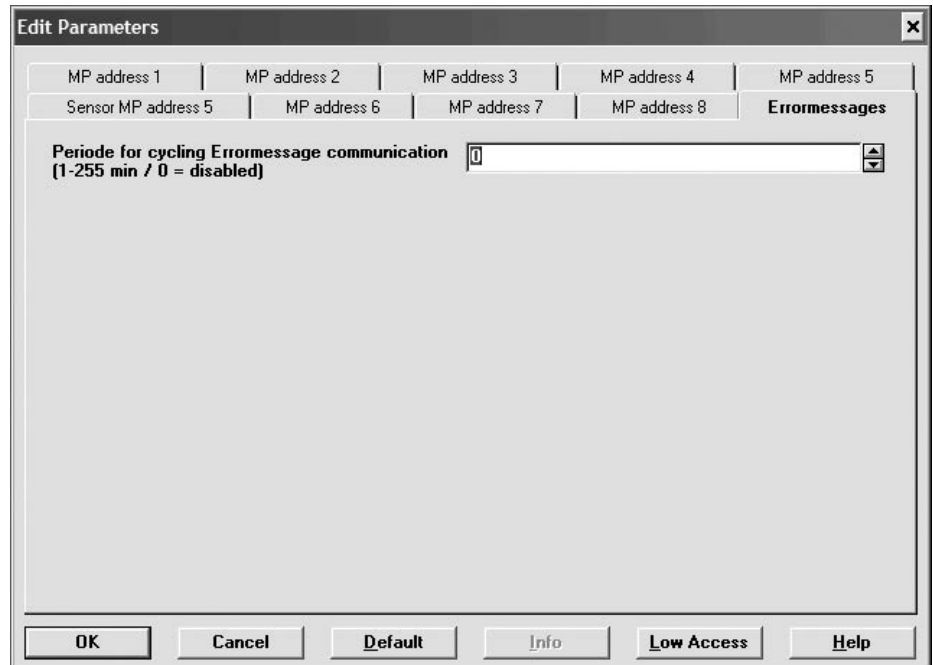

General configuration for MFT(2)/MP actuators and VAV-Compact controllers xMV-D2-MP

Setpoint monitoring time A setpoint monitoring time can be preset. If no new setpoint is received during this time it is overwritten with 0 % and the actuator closes. The monitoring is deactivated at the factory (0 minute setting) but a monitoring time between 1 and 255 minutes can be preset.

Cyclical signalling interval The actual value of damper position is signalled if it changes by a certain difference or when a preset time has elapsed. Repetition is deactivated at the factory (0 minute setting) but a repetition time of 1 to 255 minutes can be preset.

Difference value for sending the actual value The actual value of damper position is signalled if it changes by a certain difference or when a preset time has elapsed. Although the difference is preset to 4.0 % at the factory the following setting values are also available:
0.4 %, 0.8 %, 2 %, 4 %, 8 %, 10 %, 20 %.

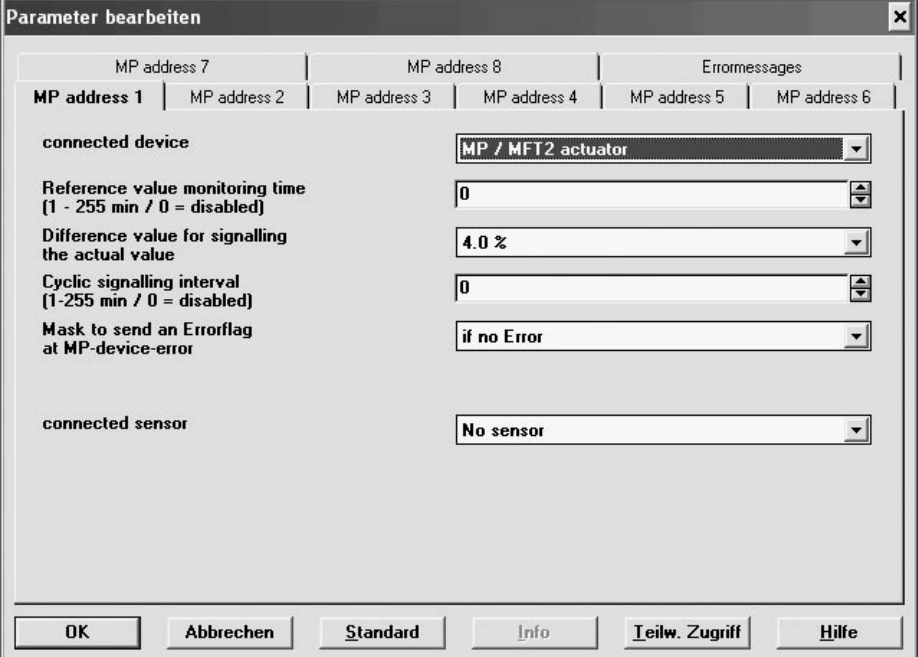

Parameter bearbeiten

MP address 7	MP address 8	Errormessages
MP address 1	MP address 2	MP address 3
MP address 4	MP address 5	MP address 6

connected device MP / MFT2 actuator

Reference value monitoring time
(1 - 255 min / 0 = disabled) 0

Difference value for signalling the actual value 4.0 %

Cyclic signalling interval
(1-255 min / 0 = disabled) 0

Mask to send an Errorflag at MP-device-error if no Error

connected sensor No sensor

OK Abbrechen Standard Info Teilw. Zugriff Hilfe

General configuration for MFT(2)/MP actuators and VAV-Compact controllers xMV-D2-MP

(Continued)

Configuration of the error mask The error mask determines which of the errors obtained from the actuator is to be output on the Low-Byte of the error status output. This is also the criterion for the error output and the error LED on the UK24EIB.

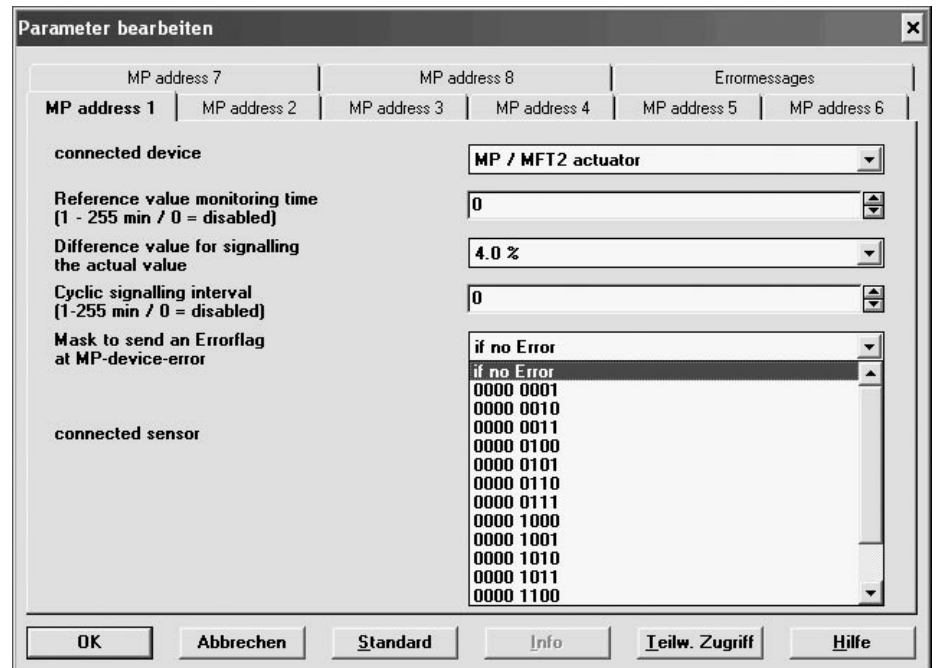

Parameter bearbeiten

MP address 7 | MP address 8 | Errormessages

MP address 1 | MP address 2 | MP address 3 | MP address 4 | MP address 5 | MP address 6

connected device MP / MFT2 actuator

Reference value monitoring time
(1 - 255 min / 0 = disabled) 0

Difference value for signalling the actual value 4.0 %

Cyclic signalling interval
(1-255 min / 0 = disabled) 0

Mask to send an Errorflag at MP-device-error
if no Error
0000 0001
0000 0010
0000 0011
0000 0100
0000 0101
0000 0110
0000 0111
0000 1000
0000 1001
0000 1010
0000 1011
0000 1100

connected sensor

OK Abbrechen Standard Info Teilw. Zugriff Hilfe

Meanings of the error bits:

0000 0001	excessive utilisation
0000 0010	increased travel
0000 0100	overload, set position not reached
0000 1000	not supported at present
0000 1xxx	not supported at present

Configuring the connected sensor with MFT2/MP actuators and VAV-Compact Controllers xMV-D2-MP

With MFT2/MP actuators it is possible to connect different types of sensor and to replicates them on the KNX via the UK24EIB unit. Belimo MFT2/MP actuators and VAV controllers support active 0 ... 10 V sensors or switches and NTC, Pt1000 and Ni1000 temperature sensors. The UK24EIB unit provides a selection which covers most of the applications encountered in HVAC work.

Kein Sensor (No Sensor)

That is the default setting. No Sensor will be shown on the EIB network and no sensor will be read out from the actuator.

The screenshot shows the 'Parameter bearbeiten' window with the following settings:

- MP address 7: MP address 1
- MP address 8: MP address 3
- Error messages: MP address 5
- connected device: MP / MFT2 actuator
- Reference value monitoring time (1 - 255 min / 0 = disabled): 0
- Difference value for signalling the actual value: 4.0 %
- Cyclic signalling interval (1-255 min / 0 = disabled): 0
- Mask to send an Errorflag at MP-device-error: if no Error
- connected sensor: No sensor

Selected sensor: Pt1000, Ni1000 or NTC 3 kΩ temperature sensors

The UK24EIB unit interrogates a Pt1000 / Ni1000 or NTC sensor cyclically from the actuator and places the value obtained, scaled in °C, on the KNX.

Difference value for signalling the sensor value

The sensor value is signalled when it has changed by a certain difference or after a preset time has elapsed. The difference is set to 1.0 °C at the factory. The following values are available for the setting: 0.5 °C, 1.0 °C, 2.0 °C, 5.0 °C, 10.0 °C.

Cyclic signalling interval

The sensor value is signalled when it has changed by a certain difference or after a preset time has elapsed. Repetition is disabled at the factory (setting 0 min); the repetition time can be adjusted between 1 and 255 minutes.

The screenshot shows the 'Parameter bearbeiten' window with the following settings:

- MP address 7: MP address 1
- MP address 8: MP address 3
- Error messages: MP address 5
- connected device: MP / MFT2 actuator
- Reference value monitoring time (1 - 255 min / 0 = disabled): 0
- Difference value for signalling the actual value: 4.0 %
- Cyclic signalling interval (1-255 min / 0 = disabled): 0
- Mask to send an Errorflag at MP-device-error: if no Error
- connected sensor: PT1000 temperature sensor
- Difference value for signalling the sensor value: 1.0 °C
- Cyclic signalling interval (1-255 min / 0 = disabled): 0

Notes

An analogue parameter assignment interface is provided for Ni1000 and NTC 3 kΩ sensors.

The sensor characteristics for the various types of sensor are permanently programmed and they must not be altered. They are correlated with Thermokon Sensor Characteristics. The Ni1000 sensor is a standard type, not the Siemens variant.

Configuration of the connected sensor in case of MFT(2)/MP actuators and VAV-Compact Controllers xMV-D2-MP
**Selected sensor: Active temperature sensor
(output 0 ... 10 V)**

The UK24EIB unit interrogates the active sensor of the actuator cyclically and replicates the value obtained, scaled according to the set parameters, in °C on the EIB. The settings for this type of sensor are stored on a separate file card because there are several parameters to be adjusted.

Difference value for signalling the sensor value

The sensor value is signalled when it has changed by a certain difference or after a preset time has elapsed. The difference is set to 1.0 °C at the factory. The following values are available for the setting: 0.5 °C, 1.0 °C, 2.0 °C, 5.0 °C, 10.0 °C.

Cyclic signalling interval

The sensor value is signalled when it has changed by a certain difference or after a preset time has elapsed. Repetition is disabled at the factory (setting 0 min); the repetition time can be adjusted between 1 and 255 minutes.

Value at 0 Volt / Value at 10 Volt

The scaling of the sensor is carried out with the help of start and end values. The setting must correspond to the data sheet supplied with the particular temperature sensor used. The UK24EIB unit supports the range from -50 to +200 °C with a resolution of 1 °C. The measuring range is set to 0 to 100 °C at the factory.

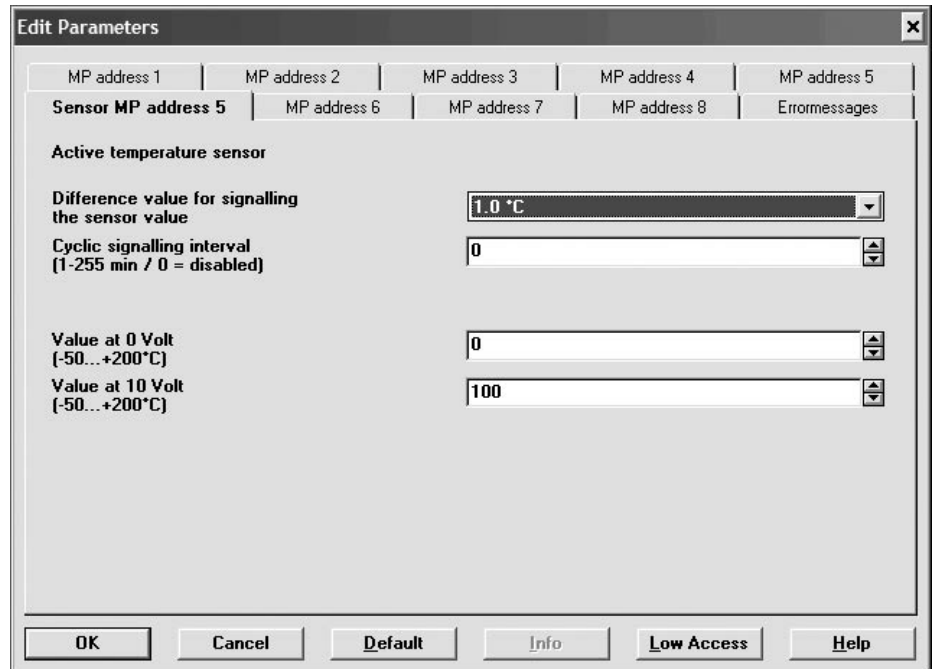

MP address 1	MP address 2	MP address 3	MP address 4	MP address 5
Sensor MP address 5	MP address 6	MP address 7	MP address 8	Error messages

Active temperature sensor

Difference value for signalling the sensor value: 1.0 °C

Cyclic signalling interval (1-255 min / 0 = disabled): 0

Value at 0 Volt (-50...+200°C): 0

Value at 10 Volt (-50...+200°C): 100

Buttons: OK, Cancel, Default, Info, Low Access, Help

Configuration of the connected sensor in case of MFT(2)/MP actuators and VAV-Compact Controllers xMV-D2-MP (Continued)
Selected sensor: Humidity sensor

The UK24EIB unit interrogates the active sensor cyclically from the actuator and places the value obtained, scaled between 0 and 100 %, on the KNX.

Cyclic signalling interval

The sensor value is signalled when it has changed by a certain difference or after a preset time has elapsed. Repetition is disabled at the factory (setting 0 min); the repetition time can be adjusted between 1 and 255 minutes.

Difference value for signalling the sensor value

The sensor value is signalled when it has changed by a certain difference or after a preset time has elapsed. The difference is set to 2.0 % at the factory. The following values are available for setting:

0.4 %, 0.8 %, 2 %, 4 %, 8 %.

MP address 7		MP address 8		Errormessages	
MP address 1	MP address 2	MP address 3	MP address 4	MP address 5	MP address 6
connected device			MP / MFT2 actuator		
Reference value monitoring time (1 - 255 min / 0 = disabled)			0		
Difference value for signalling the actual value			4.0 %		
Cyclic signalling interval (1-255 min / 0 = disabled)			0		
Mask to send an Errorflag at MP-device-error			if no Error		
connected sensor			Humidity sensor		
Difference value for signalling the sensor value			2.0 %		
Cyclic signalling interval (1-255 min / 0 = disabled)			0		

Configuration of the connected sensor in case of MFT(2)/MP actuators and VAV-Compact Controllers xMV-D2-MP (Continued)

Selected sensor: Brightness sensor (output 0 ... 10 V)

The UK24EIB unit interrogates the active sensor from the actuator and places the value obtained, scaled according to the set parameters, in kLux on the EIB. The settings for this type of sensor are stored on a separate file card because there are several parameters to be adjusted.

Percentage change for signalling the sensor value

The sensor value is signalled when it has changed by a certain difference or after a preset time has elapsed. The difference is set to 10 % at the factory. The setting range for percentage change is 0 to 100 %.

Cyclic signalling interval

The sensor value is signalled when it has changed by a certain difference or after a preset time has elapsed. Repetition is disabled at the factory (setting 0 min); the repetition time can be adjusted between 1 and 255 minutes.

Value at 0 Volt / Value at 10 Volt

The scaling of the sensor is carried out with the help of start and end values. The setting must correspond to the data sheet supplied with the particular light sensor used. The UK24EIB unit supports a range from 0 to 670 kLux with a resolution of 1 kLux. The measuring range is set to 0 to 10 kLux at the factory.

The screenshot shows a window titled "Edit Parameters" with a close button (X) in the top right corner. The window contains a grid of tabs at the top: "MP address 1", "MP address 2", "MP address 3", "MP address 4", "MP address 5", "Sensor MP address 5", "MP address 6", "MP address 7", "MP address 8", and "Errormessages". The "Sensor MP address 5" tab is selected. Below the tabs, the "Brightness sensor" section is visible. It contains four rows of settings, each with a text input field and a small up/down arrow button:

- Percentage change for signalling the sensor value:** The input field contains the value "10".
- Cyclic signalling interval (1-255 min / 0 = disabled):** The input field contains the value "0".
- value at 0 Volt (0...670 kLux):** The input field contains the value "0".
- value at 10 Volt (0...670 kLux):** The input field contains the value "10".

At the bottom of the dialog, there are six buttons: "OK", "Cancel", "Default", "Info", "Low Access", and "Help".

Configuration of the connected sensor in case of MFT actuators

Various types of sensor can be connected to MFT actuators providing a signal through the UK24EIB on the KNX. Active 0 ... 10 V sensors or switches can be connected to MFT actuators. A choice is provided covering most of the applications associated with HVAC systems:

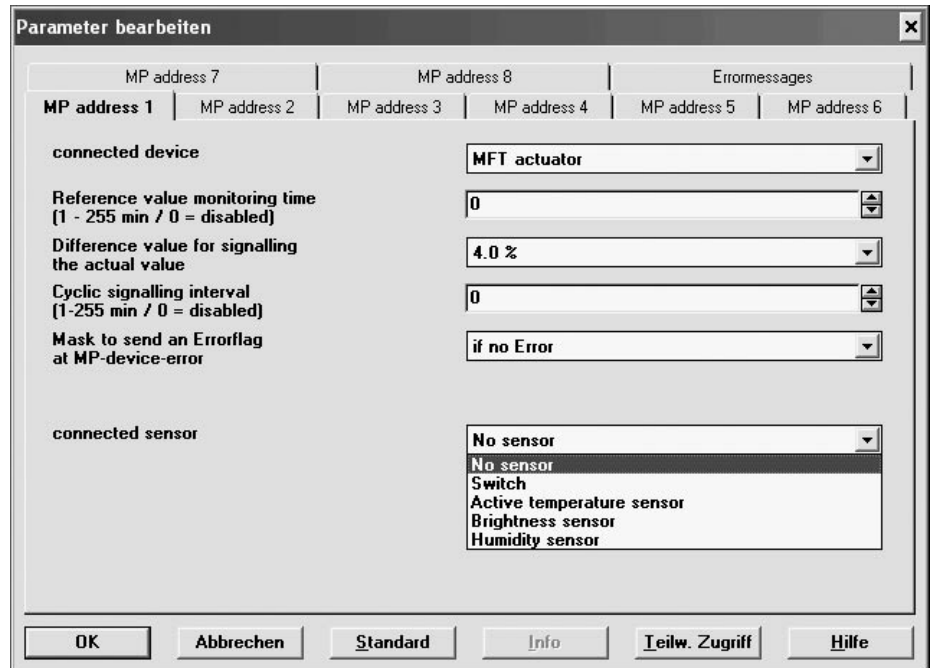

The screenshot shows a software window titled "Parameter bearbeiten" with a close button (X) in the top right corner. The window is divided into several sections:

- MP address 7** | **MP address 8** | **Errormessages**
- MP address 1** | **MP address 2** | **MP address 3** | **MP address 4** | **MP address 5** | **MP address 6**
- connected device**: A dropdown menu showing "MFT actuator".
- Reference value monitoring time (1 - 255 min / 0 = disabled)**: A numeric input field with "0".
- Difference value for signalling the actual value**: A dropdown menu showing "4.0 %".
- Cyclic signalling interval (1-255 min / 0 = disabled)**: A numeric input field with "0".
- Mask to send an Errorflag at MP-device-error**: A dropdown menu showing "if no Error".
- connected sensor**: A dropdown menu showing "No sensor". A list of options is visible below the dropdown: "No sensor", "Switch", "Active temperature sensor", "Brightness sensor", and "Humidity sensor".

At the bottom of the window, there are several buttons: "OK", "Abbrechen", "Standard", "Info", "Teilw. Zugriff", and "Hilfe".

Note

Passive sensors (e.g. Pt1000) cannot be connected.

EIB-relevant functions for VAV-Compact xMV-D2-MP controllers and MFT(2)/MP actuators

The VAV-Compact xMV-D2-MP controller and MFT(2)/MP actuators are controlled through a normal control input and a prioritised override control input. The normal control input defines the percentage position signal from an KNX message. In the case of VAV-Compact xMV-D2-MP controllers the position signal acts on the volumetric flow and, in the case of MFT(2)/MP actuators, on damper position.

For each actuator there is a feedback output which signals either the actual relative volumetric flow or the actual relative position of the damper. There is also a error flag (one group alarm per actuator) for each actuator and a error status output.

In addition, one sensor can be connected to each MFT(2)/MP actuator (also the xMV-D2-MP). This sensor is signalled to the KNX from an appropriate output.

Priority input: «Override control»

Data type: 2 Bit, priority object

Default value at power-up: 0

Function: Fully open or close the actuator first.
The override control input takes priority over the normal control input. It acts directly on damper position for all actuators.
Very suitable for central commands in order to override normal modulating operation.

Bit 1 Override enable	Bit 0 Override position	Meaning	«Reference value» control input
0	X	Normal control input active	Valid
1	0	Close damper fully	Not relevant
1	1	Open damper fully	Not relevant

Control input: «Reference value»

Data type: 1 Byte

Default value at power-up: 0

Function: The control input defines the reference position of the damper or the reference value of volumetric flow:
0 = Position signal 0 %, actuator in minimum position or \dot{V}_{\min} .
255 = Position signal 100 %, actuator in maximum position or \dot{V}_{\max} .

Position output: «Actual value»

MFT(2)/MP actuators provide a feedback signal of their actual relative position and VAV-Compact xMV-D2-MP controllers of their actual volumetric flow. The «Actual value» output provides the feedback signal of damper position or volumetric flow for the EIB as a 1 Byte value.

Data type: 1 Byte

Default value at power-up: 0

Function: 0 = Actual signal 0 %, damper in minimum position or minimum volumetric flow.
255 = Actual signal 100%, damper in maximum position or nominal volumetric flow.

EIB-relevant functions for VAV-Compact xMV-D2-MP controllers and MFT(2)/MP actuators

(Continued)

«Error flag» output The error output controls the error LED of the UK24EIB unit on the EIB. The error bit is set if it is no longer possible to communicate with the actuator or if there is a error on the Low-Byte of the error status output.

Data type: 1 Bit

Default value at power-up: 0

Function:

0 =	Actuator functioning normally
1 =	Actuator not responding or error present (e.g. overload or wrong actuator)

«Error status» output In the case of VAV-Compact xMV-D2-MP controllers and MFT(2)/MP actuators the error status read from the actuator on the KNX is reflected to this output. The error status output is 2 Bytes long. The first Byte gives the error status without a screen form and the second Byte the same information but AND-gated with a configurable error screen form.

Data type: 2 Byte, High-Byte = Error status from UK24EIB unit, Low-Byte = Error status from actuator.

Default value at power-up: 0

Function:

Error codes for High-Byte:

0b0000'0000 =	No error present
0b0000'0001 =	Connected actuator does not correspond to parameterised type
0b0000'0010 =	No communication possible at this address
0b0000'0100 =	Connected actuator signalling error, see Low-Byte
0b0000'1000 =	No valid Min / Max values
0b0001'0000 =	Non-Hall sensor motor actuators only: Actuator not yet synchronised
0b0010'0000 =	Test run active
0b0100'0000 =	Monitoring time of reference value elapsed
0b1000'0000 =	Not used

Several errors can be present together, OR-gated bitwise

Error codes for Low-Byte:

0b0000'0000 =	No error present
0b0000'0001 =	Stop & Go ratio
0b0000'0010 =	Increased position travel
0b0000'0100 =	Overload, reference position not attained
0b0000'1000 =	No support at present

The first 4 Bits are always 0.

Several errors can be present together, OR-gated bitwise

EIB-relevant functions for VAV-Compact xMV-D2-MP controllers and MFT(2)/MP actuators

(Continued)

«Sensor value» output With VAV-Compact xMV-D2-MP controllers and MFT(2)/MP actuators a sensor connected to the actuator is signalled to the sensor output on the KNX. The sensor object can be configured in terms of the measured variable and the type of sensor used. The sensor output uses a different data format according to the particular measured variable.

Switching sensor

One switch can be connected to each MFT(2)/MP or VAV actuator.

Data type:	1 Bit
Default value at power-up:	0
Function:	0 = Switch On
	1 = Switch Off

Humidity sensor

One active humidity sensor can be connected to each MFT2/MP or VAV actuator.

Data type:	1 Byte
Default value at power-up:	0
Function:	0 = 0 % relative humidity
	255 = 100 % relative humidity

Brightness sensor

One active brightness sensor can be connected to each MFT2/MP or VAV actuator.

Data type:	2 Byte, floating point
Default value at power-up:	0
Function:	Value range according to the parameter assignment of the application.

Temperature sensor

One active temperature sensor can be connected to each MFT(2)/MP or VAV actuator. A passive temperature sensor (Pt-1000, Ni-1000 or NTC 3 k Ω) can only be connected to a MFT2/MP actuator.

Data type:	2 Byte, floating point
Default value at power-up:	0
Function:	Value range according to the parameter assignment of the application.

UK24EIB Legend for operating controls

Legend

1	Power LED
2	Error LED
3	Test in progress LED
4	MP address display
5	Registered actuator LED
6	Field for inscription
7	Status LED of EIB
8	Program button for commissioning
9	Unit power supply AC or DC 24
10	SET button for MP addressing
11	Up button for MP addresses
12	Start test button
13	MP connector: For connecting MFT(2)/MP actuators
14	MFT-H connector: For connecting the MFT-H parameter assignment device or PC-Tool
15	EIB connector

The operating controls numbered 2, 3, 4, 5, 10, 11, 12 are described in greater details on the following pages

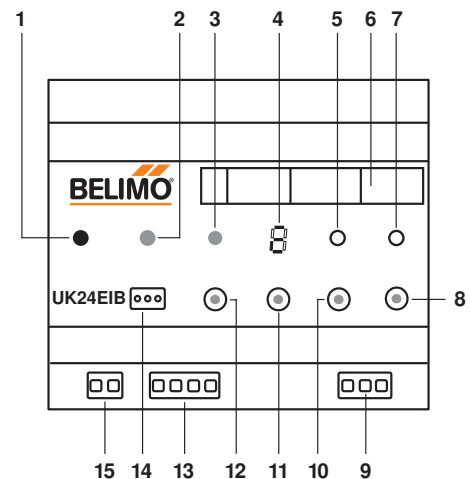

Operation, Characteristics of the UK24LON unit

Automatic scanning of the MP network

As soon as the UK24LON unit is powered up it starts scanning the MP network automatically. All eight MP addresses are interrogated cyclically to see whether there is an actuator available to respond. The results are compared against a reference table stored in the UK24LON unit. If an actuator responds from an MP address that is not assigned in the reference table it is automatically inserted into the table. If an actuator already assigned in the reference table fails to respond an error alarm is initiated but the reference table is not altered in any way. The actuators can be pre-addressed so that they are recognized automatically when they are connected to the MP network.

Manual addressing of actuators

- All required actuators must be connected first.
- Use the Up button **11** to select the address to be issued. The actual address will be shown on the display **4**.
- Use the Set button **10** to start the addressing process (hold for at least seconds). The Reg'd LED **5** starts flashing slowly (at 0.5 second intervals) to indicate that the process is in progress.
- Within the next 10 minutes the actuator being addressed must be reset at the actuator itself (in the case of xMV-D2-MP, AM and GM actuators by pressing the manual disengagement button; in the case of LF and AF actuators by moving the L/R switch back and forth and in the case of NV actuators by pressing the S2 able to recognize and address the actuator. This status is indicated by fast flashing of the Reg'd LED **5**.
- As soon as addressing of the actuator has been completed the Reg'd LED **5** gives a steady light. This also indicates that the MP address has been successfully stored in the reference table of the UK24EIB unit.

Notes on addressing

- If none of the actuators has been reset within 10 minutes of the addressing process being initiated, the process will be discontinued. The reference table remains unchanged and the Reg'd LED **5** stops flashing.
- If an address is issued that has already been assigned to another actuator the latter is automatically de-addressed first before the new actuator is addressed.
- If a mistake is made in initiating addressing, the process can be stopped by briefly pressing the Set button **10**.
- Normal data traffic on the MP network is interrupted while addressing is in progress.

Operation, Characteristics of the UK24LON unit (Continued)

Manual de-addressing of MFT(2)/MP actuators

- All required actuators must be connected first.
- Use the Up button **11** to select the address to be deleted. The actual address will be shown on the display **4**.
- Use the Set button **10** to start the deaddressing process (hold for at least 2 seconds). The Reg'd LED **5** starts flashing slowly (at 0.5 second intervals) to indicate that the process is in progress.
- Press the Set button **10** a **second time** and hold it depressed until the Reg'd LED **5** starts fast flashing.
- As soon as de-addressing of the actuator has been completed, i.e. deleted from the reference table, the Reg'd LED **5** goes dark.
- After that procedure the actuator has been reset to PP mode means conventional mode.

Notes on de-addressing

- If, after de-addressing has been initiated, the Set button **10** is not pressed a second time, the de-addressing process will be discontinued. The reference table remains unchanged and the Reg'd LED **5** stops flashing.
- If there is no actuator connected, only the entry in the reference table of the UK24EIB unit will be deleted. It will be registered again when the actuator is reconnected.
- If a mistake is made in initiating de-addressing, the process can be stopped by pressing the Set button **10**.
- Normal data traffic on the MP network is interrupted while de-addressing is in progress.

Testing the MFT(2)/MP actuators

- Use the Up button **11** to select the address to be tested. The actual address will be shown on the display **4**.
- Now start the test with the Test button **12**. The Test in progress LED **3** gives a steady light to indicate that the process is in progress. The actuator opens fully and then closes fully.
- When the test has been completed the Test in progress LED **3** goes out and the actuator returns to its last reference position.

Notes on testing

- If a mistake is made in initiating testing, the process cannot be stopped. Normal data traffic with the other actuators on the MP network is continued while testing is in progress.
- Note: By holding the button depressed for more than 2 seconds all addressed and responding actuators can be tested simultaneously.
- No mechanical testing of actuators can be initiated at addresses that have either not been registered or are incorrect.

Automatic standby mode (darkening of the display)

The displays and operating controls of the UK24EIB unit are deactivated automatically when they are not being used in order to save energy and to avoid accidental (mal-)operation. Automatic deactivation occurs approximately 2 minutes after the last time an operating control is used provided there is no mechanical testing or addressing in progress and no errors are being displayed. The unit can be reactivated by pressing the Up button **11** (for at least 2 s). It will not be possible to perform a mechanical actuator test or addressing/de-addressing until this has been done.

Error alarms from Error LED 2
1. Steady light

The UK24EIB unit can detect communication errors on the MP network. These are indicated by a **steady light** from the Error **2** LED and a display of the address affected. If several addresses are affected the lowest is displayed. The display can be advanced by means of Pushbutton Up **11**. So long as a error is still being displayed the UK24EIB unit does not change to standby mode.

2. Slow flashing

By slow flashing of the Error **2** LED and a display of the MP address affected the UK24EIB unit signals that a error bit has been set internally on the error screen form of the corresponding actuator (see «Configuring the screen form» on Page 9).

3. Fast flashing

By fast flashing of the Error **2** LED and a display of the MP address affected the UK24EIB unit signals that the corresponding actuator is not compatible with the category of actuator that has been configured in the ETS Tool (e.g. a VAV controller has been configured in the ETS but it is actually an MFT actuator that is connected).

Connecting parameterizing tools for the MFT(2)/MP actuators

Using the Belimo PC-Tool or the MFT-H manual parameter assignment device it is very easy to preset specific parameters (e.g. running time) for individual actuators. The MFT-H or the PC (PC via ZIP-RS232 interface) can be connected to the 3-pole plug socket of the UK24EIB unit to obtain direct access to the appropriate actuator. During access the UK24EIB unit signals that communication between MFT-H or PC-Tool and actuator is in progress by means of a letter **H** on the display 4.

Parameterizing with PC-Tool MFT-P

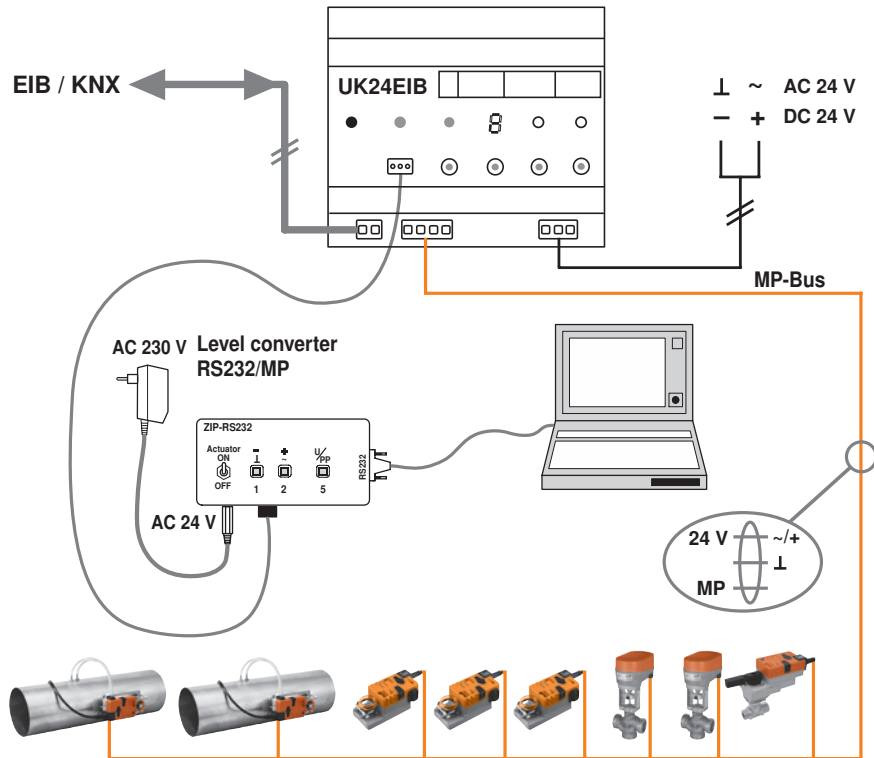

Parameterizing with MFT-H manual parameter assignment device

